



## **MPI-D, MPI-DN** **Multi-channel** **electronic recorder**

## **USER'S MANUAL**

Version: 180621 EN



This User's Manual is available also in digital version on CD-ROM.



**Before installation, carefully read all the instructions, especially those concerned with safety.**

**The recorder has been manufactured according to the requirements of relevant EU directives.**

**These instructions must be stored in a safe place near the installation of the steam flow computer at all times.**

## **Information from the Manufacturer**

All functions of the recorder are subject to modifications for the benefit of technical progress.

**HART®** is a registered trademark of HART Communication Foundation, Austin, Texas, USA



**MODBUS®** is a registered trademark of Modbus Organization, Inc., North Grafton, MA 01536 USA







**TABLE OF CONTENTS**

- 1. MARKING AND DOCUMENTATION .....6**
- 2. SAFETY INFORMATION .....7**
- 3. PURPOSE AND APPLICATION SCOPE OF THE DEVICE .....10**
  - 3.1. Purpose .....10**
  - 3.2. Available versions .....10**
  - 3.3. Basic functions.....11**
- 4. MAINTENANCE OF THE DEVICE.....13**
  - 4.1. Front panel .....13**
    - 4.1.1. Display organization .....13
    - 4.1.2. Functional buttons .....15
    - 4.1.3. LED indication .....15
    - 4.1.4. USB port.....16
    - 4.1.5. Data upload to USB flash drive .....16
  - 4.2. Analog output 4-20mA .....17**
  - 4.3. Communication with the master system .....17**
    - 4.3.1. Port RS-485 (2) .....17
    - 4.3.2. Ethernet port.....17
  - 4.4. Display.....18**
    - 4.4.1. Individual screens.....18
    - 4.4.2. Summary screens .....20
    - 4.4.3. Special screens .....21
  - 4.5. Messages .....22**
  - 4.6. Failure symbols .....22**
  - 4.7. Authorized functions, user login and logout .....22**
    - 4.7.1. Changing password by the user / administrator .....24
  - 4.8. Archive control .....24**
    - 4.8.1. Create new Archive File. ....24
    - 4.8.2. Starting, resuming and stopping archiving.....25
    - 4.8.3. Memory usage indicator .....25
  - 4.9. Browse measurement results recorded in the Archive.....26**
  - 4.10. Totaliser Archive .....27**
  - 4.11. Alarms and control.....27**
  - 4.12. Control functions.....28**
  - 4.13. Failure notification of measurement inputs .....28**
  - 4.14. User characteristics - nonlinear characteristics of measurement transmitter  
28**
  - 4.15. Audit trials.....29**
    - 4.15.1. Totaliser Log.....29
    - 4.15.2. Event Log .....30
    - 4.15.3. Authorization Log .....30
    - 4.15.4. Logs browsing on device display .....31
    - 4.15.5. Event Log Files and Authorized Operations Log Files.....31
    - 4.15.6. Remote reading of the Log .....32



5.	INTERNAL DATA MEMORY .....	33
6.	TECHNICAL DATA .....	34
7.	COMPLETE DELIVERY AND ACCESSORIES .....	39
7.1.	Content of MPI-D .....	39
7.2.	Content of MPI-DN .....	39
7.3.	Accessories .....	39
8.	ENTITY LAUNCHING THE PRODUCT ON EUROPEAN UNION MARKET .....	41
9.	ASSEMBLY AND INSTALLATION  .....	45
9.1.	Assembly .....	45
9.2.	Electrical connections .....	46
9.3.	Galvanic separation .....	47
9.4.	Power connection .....	47
9.5.	Connecting transmitters to the RS-485 (1) port .....	48
9.6.	Connecting transmitters to the HART port .....	49
9.7.	Connecting the MPI-D device as Secondary Master .....	49
9.8.	Connect signals to binary inputs .....	50
9.9.	Analog output 4-20mA connection .....	51
9.10.	Connecting receivers to binary outputs (RL1 to RL4) .....	51
9.11.	Connecting to RS-485 (2) data transmission line .....	52
9.12.	Connecting the device to the LAN using the Ethernet port .....	54
10.	DEVICE CONFIGURATION  .....	55
10.1.	Order of settings during configuration .....	55
10.2.	Administrator login (ADMIN) .....	56
10.3.	Relay outputs RL1...RL4 .....	58
10.4.	Configuration of HART and RS-485(1) inputs .....	59
10.5.	Configuration of binary PULS type inputs .....	62
10.6.	Math channels .....	64
10.7.	Failure signaling of measuring transducers .....	65
10.8.	Alarms and control thresholds .....	66
10.9.	Totalisers .....	68
10.10.	Nominal month beginning .....	71
10.11.	4-20mA current loop output (optional) .....	71
10.12.	Archiving of the results in the internal memory .....	71
10.13.	Totalisers Archive .....	72
10.14.	RS-485 port (2) .....	73
10.15.	Text messages .....	74
10.16.	Ethernet Port .....	74
10.17.	Display configuration .....	75
10.18.	Device description .....	77
10.19.	Summer and winter time - automatic adjustment .....	77
10.20.	Saving to and loading settings from a file .....	77
11.	FUNCTIONS AVAILABLE ONLY FOR AN ADMINISTRATOR  .....	79
11.1.	Changing the Administrator Password .....	79

11.2.	Administrator menu .....	79
11.3.	New firmware and licence granting .....	80
11.4.	Restoring factory settings .....	81
11.5.	Test of communication .....	81
11.6.	Functions available only for service .....	81
12.	<b>TEST FUNCTIONS</b>  .....	83
12.1.	Test of communication .....	83
12.2.	Port RS-485 (2) monitor .....	84
13.	<b>MPI-DN - WALL-MOUNTED VERSION</b>  .....	85
13.1.	Housing .....	85
13.2.	Connection of the electrical signals in the instrument MPI-DN.....	86
13.3.	Extended keyboard. ....	87
14.	<b>MPI-C-RAPORT RESULTS VISUALIZATION SOFTWARE</b>  .....	88
15.	<b>MODBUS RTU AND MODBUS TCP PROTOCOL</b>  .....	89
15.1.	Serial port settings RS-485 for Modbus RTU .....	89
15.2.	Ethernet port settings for Modbus TCP.....	89
15.3.	Readout of current results and totalisers.....	90
15.3.1.	Register addresses for current results.....	90
15.3.2.	Register addresses for totalisers .....	92
15.4.	Readout alarm threshold exceedances – function 02 .....	96
15.4.1.	Numbers of bits for reading out alarm threshold exceedances.....	97
15.5.	Reading out archives .....	98
15.5.1.	Registers' addresses for readout of archive of current results.....	99
15.5.2.	Registers' addresses to which recording is possible. ....	100
15.6.	Readout and settings of clock.....	101
15.6.1.	Registers' addresses of clock.....	101
15.7.	Function 08 (Diagnostics).....	102

Sections marked with  are available only in the CD-ROM version of this Manual attached to the recorder.

## 1. MARKING AND DOCUMENTATION

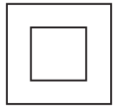

Equipment protected throughout by double insulation or reinforced insulation.



Functional earth (ground) terminal, to enable the product to function correctly. Not used to provide electrical safety.



Caution, risk of electric shock.



Caution, risk of danger, refer to accompanying documentation.



Caution, Electrostatic Discharge (ESD) sensitive circuit. Do not touch or handle without proper electrostatic discharge precautions.



Important comments and information.

## 2. SAFETY INFORMATION

Safe operation of this product can only be guaranteed if it is properly installed, commissioned, used and maintained by qualified personnel in compliance with the operating instructions. General installation and safety instructions for pipeline and plant construction, as well as the proper use of tools and safety equipment must also be complied with.

### Warning

This product is designed and constructed to withstand the forces encountered during normal use. Use of the product other than as a steam flow computer, or failure to install the product in accordance with these Instructions, product modifications or repair could:

- Cause damage to the product / property.
- Cause injury or fatality to personnel.
- Invalidate the **CE** marking.
- Void your warranty.



Isolate the mains supply before opening the product as hazardous voltages may be exposed.

### Warning

This product complies with the requirements of the following directives and harmonized standards:

Electromagnetic Compatibility (2014 / 30 / UE) by meeting the standards of:

- For EMC immunity for industrial environments according to EN 61326-1:2013 Table 2.
- For EMC conductive and radiated emissions Group1 Class A equipment according to EN 55011:2009+A1:2010.

LVD Directive 2014/35/EC to the following standards and specifications:

- Overvoltage category II, pollution degree 2 equipment according to EN 61010-1\_2010.

RoHS Directive 2011/65/EU.

The product may be exposed to interference above the limits of EN 61326 if:

- The product or its wiring is located near a radio transmitter.
- Excessive electrical noise occurs on the mains supply. Power line protectors (ac) should be installed if mains supply noise is likely. Protectors can combine filtering, suppression, surge and spike arrestors.
- Cellular telephones and mobile radios may cause interference if used within approximately 1 metre (39") of the product or its wiring. The actual separation distance necessary will vary according to the surroundings of the installation and the power of the transmitter.

### Intended use

- Check that the product is suitable for use with the application.
- Determine the correct installation situation.



- Prior to installation Metronic AKP products should take into account any environmental limitations of devices, specified in the manual.

### **Access**

Ensure safe access and if necessary a safe working platform (suitably guarded) before attempting to work on the product.

### **Lighting**

Ensure adequate lighting, particularly where detailed or intricate work is required.

### **Hazardous environment around the product**

Consider: explosion risk areas, lack of oxygen (e.g. tanks, pits), dangerous gases, extremes of temperature, hot surfaces, fire hazard (e.g. during welding), excessive noise, moving machinery.

### **The system**

Consider the effect on the complete system of the work proposed. Will any proposed action put any other part of the system or any personnel at risk?

Dangers might include isolation of vents or protective devices or the rendering ineffective of controls or alarms.

### **Tools and consumables**

Before starting work ensure that you have suitable tools and / or consumables available.

### **Protective clothing**

Consider whether you and / or others in the vicinity require any protective clothing to protect against the hazards of, for example, chemicals, high / low temperature, radiation, noise, falling objects, and dangers to eyes and face.

### **Permits to work**

All work must be carried out or be supervised by a suitably competent person. Installation and operating personnel should be trained in the correct use of the product according to the Installation and Maintenance Instructions. Where a formal 'permit to work' system is in force it must be complied with. Where there is no such system, it is recommended that a responsible person should know what work is going on and, where necessary, arrange to have an assistant whose primary responsibility is safety.

Post 'warning notices' if necessary.

### **Storage**

If an energy monitor is to be stored for a period prior to installation, the environmental storage conditions should be at a temperature between -30°C and 70°C (-22°F and 158°F), and between 5% and 95% relative humidity (non-condensing).

Before installing and connecting the power ensure there is no condensation within the unit.

### **Cleaning and maintenance**

Metronic AKP products require no maintenance beyond periodic battery replacement. Expected battery life is 10 years after the expiry of which must be returned to the manufacturer for a replacement.





From time to time you should clean the casing with a dry, soft cloth. When cleaning machine, do not use solvents or abrasives. They may cause discoloration or scratch the surfaces of device.

### **Disposal**

The MPI-D / MPI-DN contains a battery. On disposal of the unit or component, appropriate precautions should be taken in accordance with Local / National regulations.

Unless otherwise stated in the Installation and Maintenance Instructions, with the exception of the battery, this product is recyclable and no ecological hazard is anticipated with its disposal providing due care is taken.

### **Returning products**

Customers and stockists are reminded that under EC Health, Safety and Environment Law, when returning products to Spirax Sarco they must provide information on any hazards and the precautions to be taken due to contamination residues or mechanical damage which may present a health, safety or environmental risk. This information must be provided in writing including Health and Safety data sheets relating to any substances identified as hazardous or potentially hazardous.

**Prior to shipment, each product Metronic AKP is tested, calibrated and inspected to ensure proper operation.**

### **Warning**

Each carton should be inspected at the time of delivery for possible external damage. Any visible damage should be recorded immediately on the carrier's copy of the delivery slip. Each carton should be unpacked carefully and its contents checked for damage.

If it is found that some items have been damaged or are missing, notify Metronic AKP immediately and provide full details. In addition, damage must be reported to the carrier with

a request for their on-site inspection of the damaged item and its shipping carton.

### 3. PURPOSE AND APPLICATION SCOPE OF THE DEVICE

#### 3.1. Purpose

MPI-D and MPI-DN are versions of a multi-channel microprocessor-based measuring device with electronically recorded measurement results. The recorder is intended to measure process values in industrial applications. It is designed to work with devices and sensors that communicate by digital bus:

- RS-485 standard with Modbus RTU protocol,
- HART standard (also in multidrop configuration).

With the special structure of the processing route applied, this recorder is perfectly suited for slow variable runs with changes taking place at a few seconds intervals.

Extended functions of events and process values recording make it possible to perform analysis of technological processes and emergency conditions. Data recording of process values enables to use this device in places beyond the reach of computer networks. Four output relays provide with signalling and simple controlling.

#### 3.2. Available versions

The device is manufactured in two different casings – for panel mounting (MPI-D) and wall mounting (MPI-DN). Both versions have the same metrology functions. MPI-D version requires 24 V AC/DC power supply, and MPI-DN version is adapted to be powered from 24 V AC/DC or 230 V AC. Optionally both versions can be equipped with an analog output 4-20mA.

Offered versions of the devices:

MPI-D	- x	
	- 0	version without analog aoutput 4-20mA
	- 1	version with analog aoutput4-20mA

MPI-DN	- x	
	- 0	version without analog aoutput 4-20mA
	- 1	version with analog aoutput 4-20mA

Devices are available in four language versions:

- Polish,
- English,
- French,
- German.

Language change is available from the device keyboard.

**!** Due to the slight differences between the versions of MPI-D and MPI-DN manual describes the version of the MPI-D. Information about differences in MPI-DN are given in Chapter 13.



## 3.3. Basic functions

### • **Measuring channels**

MPI-D can display up to 20 measuring channels. 18 channels is used to read the digital HART protocol (only PV - primary variable, SV - secondary variable, TV - third variable FV - fourth variable), or Modbus RTU via RS-485 (1) port. The remaining two channels are used to display PULS inputs.

PULS-type inputs can operate in one of three modes:

- **binary inputs mode**, can trace circuit closing/opening, each of the two binary states(conditions) can be assigned to any analog value (e.g. -1.00 / 10.0), value corresponding to binary state can be used in simple controlling operations or as a value in calculated values (e.g. flow direction);
- **frequency measure mode**, in range between 0.001 Hz and 10 kHz, programmable frequency range allows the scaling of the measured value to engineering units (e.g. flow);
- **pulse counting mode**, should be selected if a transmitter with constant pulse weight is connected to the binary input.

PULS inputs can be connected with binary pulse transmitter (contact, transistor in OC configuration), the source of voltage or current pulses and in the NAMUR standard.

### • **Calculated values**

Based on the measurement results, intermediate values can be calculated and defined with user-specified formulas. The recorder handles addition, subtraction, multiplication, division and extraction of roots, as well as multiplication or addition of a fixed value. You can add channel values (e.g. to define the total value of several flows), calculate arithmetic or geometric mean (e.g. average temperature), compare two values (e.g. percentage share of either of two compared flows), difference (e.g. pressure difference between two independent pressure sensors). There are 16 calculation channels available that offer the same functions as measuring channels and can support alarm, control and recording functions.

### • **Totalisers**

Each measurement input (incl. binary inputs) and each calculated value have two independent totalisers assigned. Totalisers can measure slow variable flows, etc. Totalisers for pulse inputs can provide precise pulse aggregation. For channels 1 to 18 values of totalisers can be read via HART and Modbus RTU port as well.

### • **Results recording**

Measurement and calculation results as well as totaliser readings can be recorded in the recorder's internal memory with the capacity of 2 GB. Data are saved as text files protected with encoded checksum. Apart from the measured values, the recorder also saves events (power loss, resetting, exceeded threshold values, etc.) and authorized operations. Internal memory can save up to 250 files.

### • **Results displaying**

Measurement results can be displayed on the recorder screen or moved to a PC. There is a backlit TFT LCD display and three tri-color LEDs on the face plate. Depending on the configuration, the measurement and calculation results are displayed as large digits, analog information or graphs. The results can be also displayed collectively as



tables or bar charts. Measurement screens can be browsed sequentially or set to a selected channel.

- **Functional buttons**

MPI-D has seven functional buttons. Buttons can have different functions, depending on the currently displayed information. They allow to fully configure the device. MPI-DN device have an extended 19-button keypad.

The key functions can be protected with a password and user name.

- **Relay outputs**

Four solid-state output relays which can be assigned to alarm and control thresholds, allow to implement a signalization of exceedance and a simple two-state control. Relays can also be configured to work as pulse outputs. Then a relay is assigned to one of the available totalisers. Number of pulses corresponds to totaliser incrementation.

- **Analog output 4-20mA (optional)**

The instrument can be equipped with an analog 4-20mA current loop output. This output can trace the channel value (measured or calculated) in range set by user. The current loop can be powered from a device with an internal voltage source +24 V or from an external voltage source. The current output is galvanically isolated from other circuits in device. The output is optionally assembled

- **Communication with a computer system**

The instrument can be incorporated into the master computer system by:

- built-in serial RS-485(2); available ASCII and Modbus RTU protocol,
- Ethernet port (web server).

- **Supplementary software (optional)**

Additional MPI-D-Raport software facilitates the recorded results overview and handles basic mathematic processing and data selection.

## 4. MAINTENANCE OF THE DEVICE

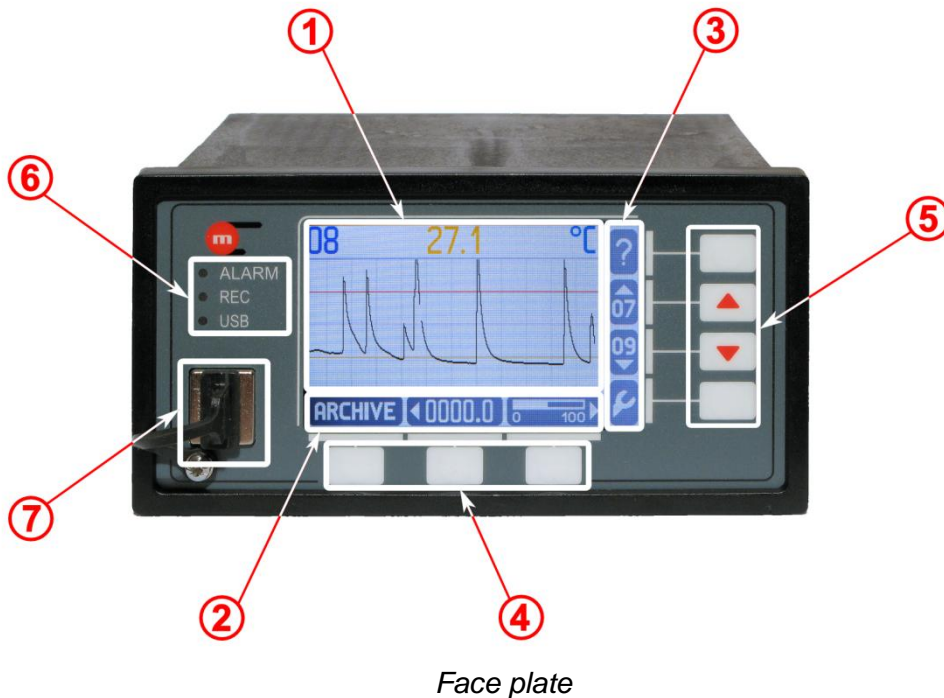

### 4.1. Front panel

#### 4.1.1. Display organization

The display along with buttons is a basic element of communication between the device and a user. It displays following information:

- results of measurements,
- messages,
- archive menu,
- settings menu,
- pictograms of the function buttons (keypad).

Display can be divided into three main areas:

- 1) area of results ①,
- 2) area of pictograms of three lower function buttons ②,
- 3) area of pictograms of four side function bottom ③.

Pictograms of measuring channels:



channel 01



channel 03

Other channels as above.

Additional screen pictograms:



„Main archive”



„Data and time”



„Relay outputs”



„Thresholds”



„Bar chart”



„Table”

Summary screen pictograms:



„Table” defined by user

Measurement screen pictograms:



“Large digits” – digital display with large digits



“Trend graph” – graphical display of data



“Bar graph” – display with an analog line



„Min, max” – minimum / maximum / average values in a table



„Min, max” – minimum / maximum / average values in an analog line

Other pictograms:



Settings – return to the MAIN MENU and settings



Full screen display (archive browsing)



Help – help function call and additional information



Recorder name, firmware version, serial number and recorder description (can be edited by user)



„Exit” – exit to the previous menu or abandoning an operation

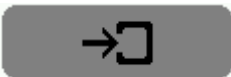

„Enter” – go to the next menu



„OK” – confirm a message or accept an operation

#### 4.1.2. Functional buttons

There are 7 (MPI-D) or 19 functional buttons (MPI-DN, see section 13.3) on the front panel. Each function button can perform different actions depending on an operational state of the flow computer and information displayed on the screen. To simplify a handling of the device, on the screen are displayed pictograms which symbolize buttons functions active at the moment.

#### 4.1.3. LED indication

On a front panel are located three LEDs © marked as:

- ALARM – when the device is in an alarm state it lights up in **red** (constantly or blinking), it is accompanied by a message explaining the cause of the alarm, **green** color reminds to log out after completing authorized operation
- REC – constant **green** light indicates recording data into an internal memory, pulsing **green** light indicates opening/closing a file, **red** color indicates an error in the archive function.
- USB – it lights up in **yellow** when USB controller is on, **green-yellow** flashing indicates reading/recording data, **red** light indicates an error (e.g. lack of USB flash drive during reading/writing data).

#### 4.1.4. USB port

The USB port type A is located on the front panel. It is designed for connecting an external flash drive that allows data transfer between the device and a PC. The socket has a high level of protection IP54 (protection against ingress of dust and water inside the socket).

**!** MPI-D cannot support advanced directory and subdirectory structure that can be saved on an USB flash drive. It is recommended to use a suitable USB mass storage device (USB flash drive) that can be supported by the recorder.

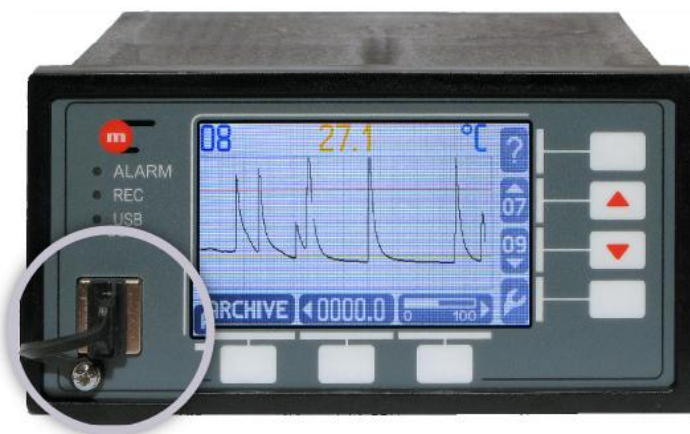

USB port

**!** If the mass storage device is disconnected from the USB port when the USB LED is lit (yellow and green-red), all data saved on the mass storage device can be lost.

#### 4.1.5. Data upload to USB flash drive

In order to copy files to a USB mass storage device, go to  → **Main menu** → **Copy files**. Select **Current archives** to copy the current archive file, totaliser archive file and log files. Select **Choose file** to be able to select files from a list. When the files are being copied, the USB mass storage device must be plugged into the USB socket. The 'copy' function can be password-protected and available to authorized users only.

Files can be also moved or deleted. Note that specific files are accessible to SERVICE users only.

To read data, plug the USB flash drive into USB port on a PC. The mass storage device will be displayed as an additional computer disc, and the data will be saved as text files.





*Mass storage device (USB flash drive)*

#### **4.2. Analog output 4-20mA**

The device can be equipped with the optional analog output 4-20mA. The output can trace a signal linearly dependent on the value chosen from the reading values, which is measured or calculated. The output range have to be set during configuration and assign to one of the channels. The output cannot trace the totaliser.

#### **4.3. Communication with the master system**

MPI-D device can communicate with the master system through:

- RS-485 (2) - ASCII and Modbus RTU protocols;
- Ethernet port - Modbus TCP protocol, Web server.

**!** The communication via the RS-485 (2) port have no effect on communication via the Ethernet port and vice versa.

##### **4.3.1. Port RS-485 (2)**

The following data can be remotely accessed via RS-485 port:

- current results (ASCII and Modbus RTU),
- the archive of the current results (the most recent file only, ASCII and Modbus RTU),
- 500 recently recorded events (ASCII only),
- 500 recently recorded authorized operations (ASCII only),
- totaliser files, event log and authorized operations log (ASCII only),
- status and information about the current results recorded in the archive (ASCII and Modbus RTU),
- recording control (start, stop etc., ASCII only).

Connecting GSM module to RS485(2) port enables to transfer as a text messages (SMS) information about selected alarms and failures and measurement values and totalisers.

##### **4.3.2. Ethernet port**

The device features an Ethernet communication module with Modbus TCP protocol to connect the recorder to a master computer (PC, PLC) via industrial Ethernet network. The following data can be remotely accessed via Ethernet port:

- current results,
- the archive of the current results (the most recent file only),

- status and information about the current results recorded in the archive.

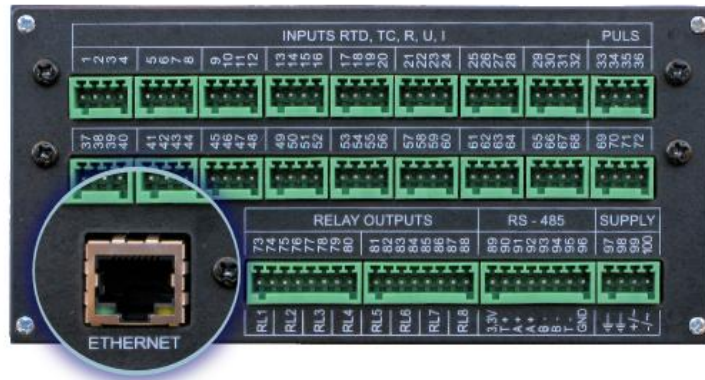

Fig. 4.1 Ethernet Port

In Modbus TCP the Ethernet module can open simultaneously up to 4 connections. Thus, it is possible to query the device from 4 different computers or systems. Data from measuring channels are available in two formats: Integer and Floating point.

For Ethernet port also a web server is available by IP address in the standard browser. In this way it is possible to monitor all measurement and math channels, totalisers, check the status of the analog output and relay outputs as well as visualize the obtained data in a graph representation (TREND).

User can select *Settings* button to define channels to be displayed on the graph and to change the trend line color and the refreshing time of the graph. The web server is available in four languages: English, German, French and Polish. The read-outs of data and the number of connected clients (up to 4) via the Ethernet port have no effect on the communication via the RS-485 port.

**!** The web site was tested with Explorer 8, Opera, Mozilla Firefox, Chrome and Safari browsers.

## 4.4. Display

### 4.4.1. Individual screens

Measurement and calculation results can be displayed in six various forms, as measurement screens.

1. „Large digits” – measuring channel number and results are displayed in large, easy to read digits (approx. 12 mm) along with channel description and unit.

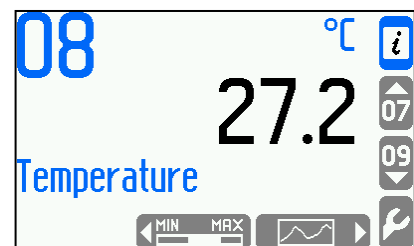

2. „Trend graph” – graphic representation of the measured quantity with results displayed on a time graph (for at least 353 recent measurement points) along with digital read-out of instantaneous value and unit. Alarm / control thresholds are displayed on the graph (if set for the relevant channel), and the instantaneous value is displayed in the assigned color after a specific threshold

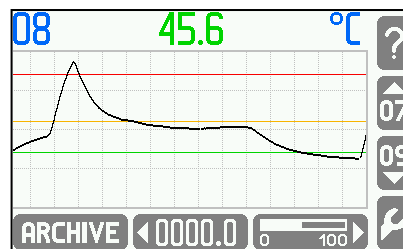

is exceeded (yellow in the shown example). With button, you can monitor the time axis scale and graph value.

3. „Bar graph” (analog line) – digital result along with a unit and description and an analog line indicating the location of an instantaneous read-out against a pre-defined scale; the analog line also shows the points of alarm/control thresholds (if set).

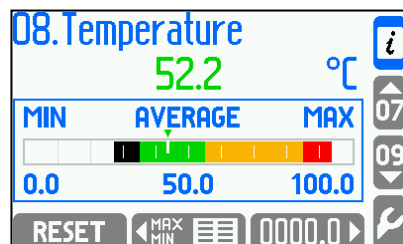

4. „Min, max” (minimum, maximum, average) – digital result along with a unit and description and a table with minimum, maximum and average values saved, and the date and time of the beginning of calculation. Use **RESET** to reset the values. A password might be required.

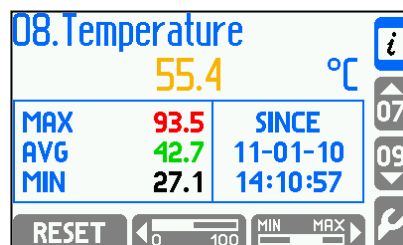

5. „Min, max (bar)” – digital result along with a unit and description and an analog line (bar graph) indicating the minimum, maximum and average value against a pre-defined analog scale. Likewise, use **RESET** to reset the values. This function might be pass-word protected.

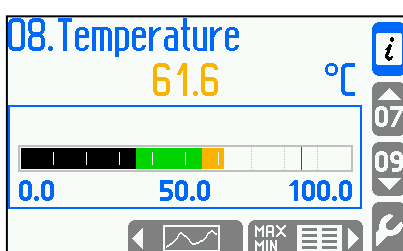

6. „Totalisers” – digital result along with a unit and description and the totaliser status. Use **RESET** to reset one or both totalisers. This function might be password-protected.

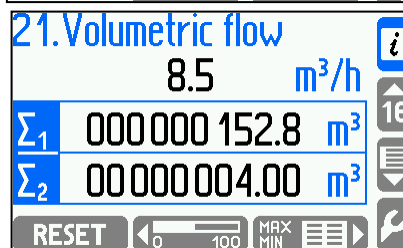

**!** When setting the parameters, you can also select the way the results are displayed and switch off specific measurement screens. It is easier to operate the recorder by limiting the number of superfluous functions.

One of the active screens can be set to a "default screen" displayed when a specific measuring channel is selected. Each channel can have a different number of screens and a different default screen assigned. Measuring channels can be browsed manually or can be displayed in a sequence.

### Manual channel selection:

To select a measuring channel, use the middle buttons from the four side buttons (▼,▲). Press and release a button to display the next measuring channel. The available channel number is indicated with the button icon. In the manual mode, all enabled channels are available.

### Auto-browsing of channels:

Press and hold the channel selection button (▼,▲) when browsing through measurement screens to switch to automatic display of measurement results from subsequent channels, in an ascending or descending manner, respectively. Only channels set to **Auto-browse** → **YES** under device settings will be displayed in the automatic mode. You can now browse through a selection of only the most important channels shown in a sequence. The remaining channels are available in the manual mode. To disable the “auto” mode, press and release any button.

### Changing measurement screens:

Use the middle and the right button from a group of three buttons at the bottom of the display to change the measurement screen. Only screens defined as **Visible** or **Primary** under device settings are available. You can set different screens for each channel. The next available screen is indicated with the button icon.

## 4.4.2. Summary screens

Apart from individual screens and special screens, summary screens are also available. One can define up to 6 tables, and each of the tables (depending on the type: uppercase or lowercase) can include 6 or 3 results (measurement results, calculation results, totalisers).

1. „Table” – defined by user, featuring three result lines. The table names can be edited by the user.

Steam boiler 1			i
01	-1.1	°C	▲
08	98.3	°C	▼
05	265.2	°C	↻

2. „Table” – defined by user, featuring six result lines.

Steam boiler 2			i
01	-1.1	°C	▲
04	48.6	°C	▼
05	265.2	°C	↻
21	9.0	m <sup>3</sup> /h	▲
Σ121	000 000 006.4	m <sup>3</sup>	▼
08	98.6	°C	↻

Summary screens are available in the manual and sequence mode. Press to go to the next/previous table.

### Auto-browsing of summary screens:

Press and hold the channel selection button (▼,▲) when displaying summary screens to go to automatic display of subsequent tables, in an ascending or descending manner, respectively. Only tables set to **Auto-browse** → **YES** under device settings will be

displayed in the automatic mode. You can now browse through a selection of only the most important tables shown in a sequence. The remaining tables are available in the manual mode. To disable the “auto” mode, press and release any button.

### 4.4.3. Special screens

Apart from individual screens and summary screens, special screens are also available.

1. „Thresholds” – this screen displays exceeded pre-programmed alarm/control thresholds. Each measuring channel can have up to four thresholds assigned; ▲ or ▼ indicates that the max or min threshold has been exceeded, respectively.

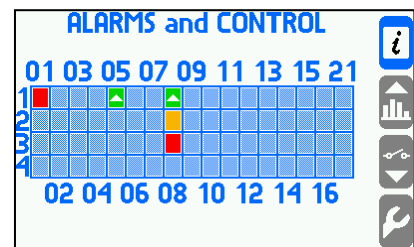

2. „Relay outputs” – this screen illustrates the current status of eight output relays. Relays set to “disabled” (deactivated) mode are not displayed.

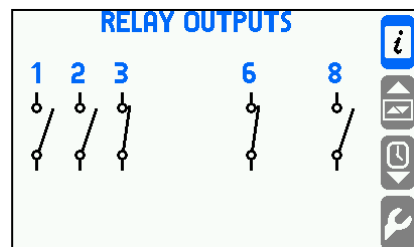

3. „Data and time” – this screen indicates the clock settings. Press **CHANGE** to introduce new time settings. Clock settings are important when the measurement data are recorded. You might need a password to change the date and time.

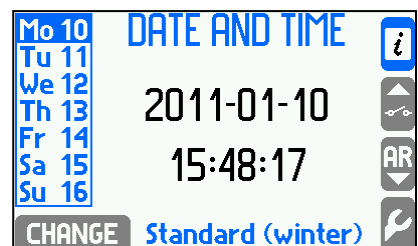

4. „Main archive” – this screen shows the recording status: recording, stop (recording hold-up), current recording speed and memory usage indicator. Press **REC** / **STOP** to start/stop recording. Press **MENU** to go to advanced archive control functions (setting up a new archive, resetting the memory usage indicator). Press **MORE** to display detailed information about the recording status. You may need a password to control the recording function.



5. „Bar chart” – a summary screen with results arranged into a bar chart.

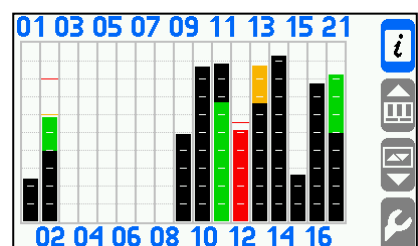

6. „Table” – a summary screen with results arranged into a table.

RESULTS 01...21					
01	-1.1	07	266.7	13	-F-
02	-F-	08	92.6	14	-F-
03	-F-	09	-F-	15	-F-
04	48.7	10	-F-	16	-F-
05	265.3	11	-F-	21	8.6
06	45.2	12	-F-		
2011-01-11			09:19:53		

„Special screens” can be set as **Visible** or **Invisible** (not shown on the display) under device settings. Additional screens are displayed when results are browsed manually (using ▲, ▼ buttons), following the last measurement screen. The special screens can be disabled in a sequence browsing mode.

#### 4.5. Messages

The MPI-D interface is intended to make device operation as user-friendly as possible. Many states and reactions of the device trigger the display of information messages. These messages need to be confirmed with the **OK** button. Messages will only disable measurement functions in the event of a critical emergency status.

#### 4.6. Failure symbols

Failures associated with particular channels are marked with appropriate symbol on the display.

Symbols of failure:

- -F- lack of communication via HART or RS485;
- -R- exceeding the range;
- -W- wait;
- -C- internal communication error.

Symbols of failure are displayed instead of the result for all related channels, eg. for measurement input and the calculation channel in which the result is used.

#### 4.7. Authorized functions, user login and logout

Some functions can be password-protected. Up to 25 users can be defined, and each user will be assigned a unique password. ADMIN is the user who can operate all functions (apart from servicing). Depending on the intended use of the recorder, each user can have individual password-protected operations assigned. Specific operations can be also accessible to all logged-in users.

Password-protected functions can be accessed as follows:

- Each time the function is selected, the user needs to enter the login and password.
- When the login and password are entered, a green ALARM LED is lit. The user is then authorized to use all password-protected functions (if authorized to do so) without the need to enter the password before each single operation. Remember to log out when you are finished. Otherwise you will be automatically logged out after 30 s, 1, 2, 3, 5 or 10 minutes (idle time).

## User login:

Press (Settings) in the **Main menu** to select **Log in** and then chose the user from the list. Press **SELECT** and enter the password. The password can be composed of 3 to 6 digits (excluding 0). Use the lower buttons to enter the password, press each button twice. For example, to enter 4, first press the group of three digits **4,5,6**, and then press **4**. To log out, select **Log out** function in the **Main menu**.

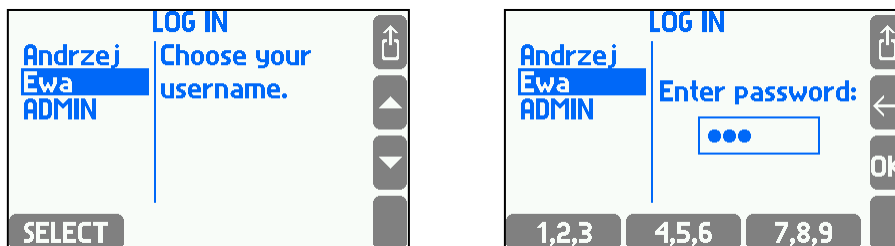

Only the administrator can define a protected activity, add new or delete existing users. ADMIN can also change user's password without its knowledge. The user can change only its own password.

Commands that can be password protected after proper programming:

- Archiving commands (creating a new file, starting and pausing recording, clearing indicator).
- Copy files (copying and removing files from the internal memory with the exception of the files that can be removed / transferred only by SERVICE).
- Resetting min, max (resetting tracing minimum, maximum and average value).
- Clock adjusting.
- Resetting totalisers (the resettable ones).
- Main settings (changing any settings except those three mentioned below).
- Threshold settings (changing the levels and hysteresis of alarm and control thresholds).
- Screen settings (configuring screens and changing display settings).
- Archiving settings (changing archive-related settings e.g. selecting recorded items).

The administrator decides which of the above actions require authorization and which users are allowed to perform them. If no user is given permission to the activity, the only legitimate is an administrator.

Features available only for the administrator (always password protected):

- Administrative data (choosing password-protected commands, define users, their passwords and entitlements)
- Audit trials – browsing on the device screen,
- Communication test,
- Firmware and licenses (installing new firmware and granting licenses),
- Restoring factory settings.

Features available only for the SERVICE (ADMIN with service privileges):

- Calibration of measuring inputs.
- Deleting/moving the event log, authorization log and calibration log.



**!** The administrator password (the user ADMIN) in the new device is: **1**. Only in the new device is a single-digit ADMIN password for ease the first programming of the device. This password should be changed by an administrator to another soon after programming the device.

**SERVICE password:** Obtaining the service password is possible after contacting the manufacturer. To do this, generate the same digital code as if you forget the ADMIN password and provide it to the manufacturer.

#### 4.7.1. Changing password by the user / administrator

Each user can change his/her user password. To change your password, log in and select **Change password** in the **Main menu** and enter a new password.

Instructions on how to change administrator password are provided below.

**!** The administrator can change each user password even if you have forgot the password.

■ If the administrator password is forgotten, it is necessary to contract the manufacturer. You will then be asked to provide a numerical code. To generate the code, enter any password and select **NEW**. A new password will be assigned on the basis of this numerical code.

#### 4.8. Archive control

The recorder has an internal memory with the capacity of 2 GB. The recording process can be set with the buttons on the face plate:

- creating a new archive file,
- starting (restarting) the recording of current results,
- finishing (stopping) the recording of current results,
- resetting the memory usage indicator.



After the archiving process is finished, data can be uploaded to a PC by means of a portable mass memory storage device plugged into the USB socket. Optional *MPI-C-Raport* software can analyze the results and draw up and print reports (see Section 14).

##### 4.8.1. Create new Archive File.

Creating a new data set for archiving can be done from two locations: the additional screen **MAIN ARCHIVE** or → **Main menu** → **Archiving commands**.



On the **MAIN ARCHIVE** screen select **MENU** → **New file** → . Then appears the question: “Do you want to create a new Main Archive file?” Confirm with the button **YES**. After accepting the REC LED blinks **green** for a few seconds during the operation. In the internal memory of the device is created a text file: *ar[addr]\_[count].txt*. The *addr* is a two-digit address of the device, and the *count* is the serial number of created file (in one instrument it is impossible to create two archive files with identical name). An example of the file name: *ar01\_004.txt*.



To distinguish between files from different devices is recommended to configure different addresses even when the RS-485 transmission is not used.

Then the message appears that the new archive has been created along with the estimated time of filling the internal memory, and question “Do you want to START RECORDING?”. To start archiving to the newly created file press button **YES**.

Function of creating a new archive can be password protected. User with entitlement to **Archiving commands** may not have permission to delete archived files.

Similarly, creation of the new archive file by pressing button → **Main menu** → **Archiving commands** → **New file**.

#### 4.8.2. Starting, resuming and stopping archiving

The most convenient way to start or stop the archiving process is using the **MAIN ARCHIVE** screen. When the archiving is stopped available is quick-start button . If archiving is on, the same button takes the form of , and enables to stop the archiving. After stopping, user can resume recording by pressing the button , then the archiving will continue, and the results are appended to the current file existing in the internal memory. Both, start and stop the archiving requires double confirmation. These functions can also be password protected.

Both functions can be also activated from the **MAIN ARCHIVE** screen: **MENU** → **Resume/Stop recording**

and from **Main menu**: → **Archiving commands** → **Resume/Stop recording**.

#### 4.8.3. Memory usage indicator

The **MAIN ARCHIVE** screen provides information about percentage of data occupancy in the internal memory and the expected date and time of filling. This is only estimated time. In particular, when working with two recording speeds (for example, dependent on exceedances of alarm and control thresholds), this information may significantly fluctuate. Also archiving pause may extend that period.

In the **Successive files** archive mode, if a day / week / month limitation is selected, instead of the predictions device shows actual date and time of the next file creation.

In archive mode **Overwrite**, archive indicator can be reset. Using this, a user can marks the date and time when archive was read last time. Then the indicator means overwriting the results from the last reading. Resetting indicator index can be performed from the **MAIN ARCHIVE** screen: **MENU** → **Reset usage indicator** or from **Main menu**: → **Archiving commands** → **Reset usage indicator**.

## 4.9. Browse measurement results recorded in the Archive

The results of measurements stored in the device's memory can be viewed on the display in the table or in graphical form. This feature is rather a preview. Advanced analysis of the results should be done on the computer using dedicated software, where the possibilities are much more extended.

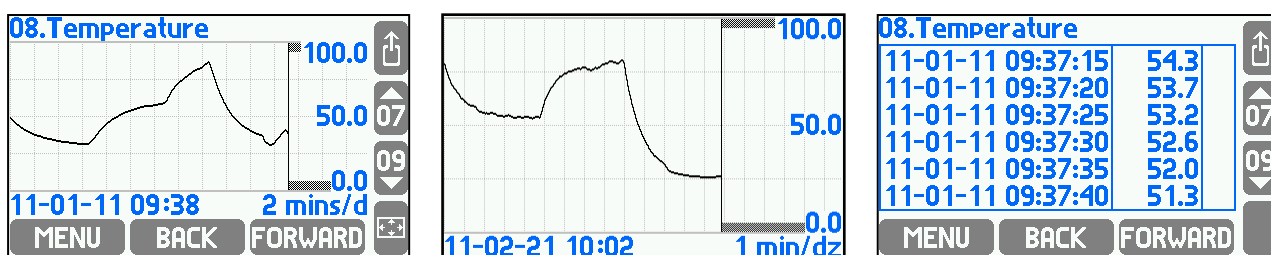

To enter results browser select: → **Main menu** → **Archiving commands** → **Browse** or from detailed screen **Trend graph** with the button **ARCHIVE** or from the additional **MAIN ARCHIVE** screen with the button: **MENU**. Using the buttons **BACK** and **FORWARD** archive can be browse in time axis, and the buttons „▲” and „▼” can be changed subsequent archived results for the selected time interval.

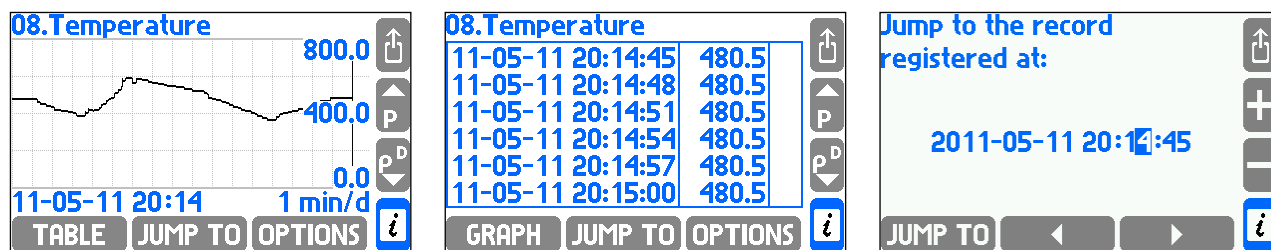

The scope of the presented time interval is dependent on the frequency of archived results (influenced by both of the frequency I and II) and cannot be changed while viewing. Selected scope can be enlarged to full screen with the button (to return to the original size press any button). After pressing the button **MENU** additional browsing functions are available:

- JUMP TO** - searching the course of a specified date and time;
- TABLE** - presenting results in a table;
- OPTIONS** - following options:

- **Autoscaling** – automatic scaling of the y-axis plot, when values are out of defined range,

- **Substituted values** – show the assumed values during measurement failure (substituted measured values of the sensor while failure is detected, the correct function must also be enabled in the settings of measuring inputs),

**Large chart legend**– axis scale in full screen mode (  )

## 4.10. Totaliser Archive

Totalisers value are recorded in the Hourly Archive file which is created automatically if at least one totaliser or process value is declared for registration. There is always only one Hourly Archive file even if settings were changed. When changes are completed only a new header is recorded to a file. When the file is deleted or moved from the internal memory, the device automatically creates a new one.

The name of totaliser archive file is *artot[addr].txt*, where *addr* is a double-digit device address. The file can be copied or moved to an external USB memory device, and then transferred to a computer. The data in the file are secured with control fields, that allow to determine whether they have been modified outside of the instrument.

**!** To distinguish between files from different devices is recommended to configure different addresses even when the RS-485 transmission is not used.

## 4.11. Alarms and control

In the device can be set up to four alarm and control thresholds for each process values. Each threshold has the individually adjustable level of activation, hysteresis, "High" or "Low" mode and can realize the alarm function and / or the control function. Every threshold can be assigned also with a color (green, yellow, red). Exceeding the threshold is indicated by changing a color of the result to the color assigned with the alarm. When more thresholds are overrun the result color is changed to a color of the higher threshold.

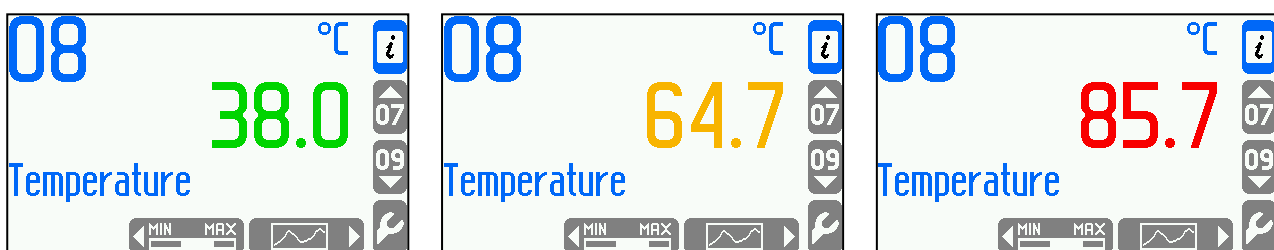

Alarm functions:

- Exceedances reporting – on the front panel the ALARM LED starts blinking in **red**, on the screen is displayed a message about the channel number and the date and time of the exceedance. If more exceedances are reported, the messages are queued. User can browse all notifications by pressing **OK** button or confirm all reports at once without browsing by pressing **ALL** button. After confirming all notifications the ALARM LED lights in **red** if at least one exceedance remains. If all exceedances are over, the ALARM LED turns off. If the notification of the same alarm reappears without previous confirmation, only the first message in the message queue is stored.



- Color change of a result for which the exceedance occurred (the result is displayed in a color assigned to the alarm and control thresholds).
- Excitation of the output relay – an alarm notification can be linked with excitation of the output relay (for example to connect the sound signalization). Confirmation of displayed notification ends the excitation of the relay. At the programming settings phase, user defines output relays and assign them to the appropriate alarm and control thresholds.
- Marking an exceedance on the "Alarm and control thresholds" screen – exceeding of the alarm and control thresholds is shown graphically on the screen in a form of symbols ▲ or ▼ respectively for the upper and lower excess and with the color assigned to a particular threshold. On this screen are shown simultaneously control exceedances.
- Recording the exceedances in the Event log - exceedances can be recorded in the Event log, depending on the programming, recorded can be just a notification about exceedance, the notification and its ending or just ending. Confirmation about the notification of message is not recorded.

## 4.12. Control functions

Using four alarms and control thresholds (with hysteresis) assigned to the results, and four freely programmable output relays, the device can perform simple "on / off" control functions. Control does not require user support. User can preview the status of the threshold on the detailed screen of the "Alarm and control thresholds" and the state of output relays on the additional screen **RELAY OUTPUTS** if these screens have not been hidden when programming the device. Exceeding the thresholds during the control can also be recorded in the Event log.

## 4.13. Failure notification of measurement inputs

Lack or error in communication with the sensor assigned to the particular input is treated as a failure and marked on the display with the "-F" (failure) symbol. Detection of a failure may trigger displaying the appropriate message and then require confirmation by the user even if the cause of the failure ended earlier. Depending on the settings during programming the device, a failure may cause the excitation of corresponding output relay till the confirmation or for the entire duration of failure. Failure and its disappearance may be recorded in the Event log.

## 4.14. User characteristics - nonlinear characteristics of measurement transmitter

The recorder can also accept the current loop or frequency signal other than linear or square root. Transmitter's characteristic is upload to the device as a file. Such file should be prepared on a PC computer in a text editor or in a spreadsheet and copied to the USB Flash Memory (pendrive). Accepted extensions are .txt and .csv. An example of the file contents with the transmitter's characteristic with frequency signal is given below.

```
#char Nonlinear
100.0 30.0
200.0 40.0
300.0 52.0
```

A file must begin with string #char which is followed by the name (up to 12 characters, here `Nonlinear`). In the next line the table starts with two columns of numbers: transmitter signal in Hz (or mA for current loop transmitter) and corresponding measured value. The table must be ordered in sequence of growing signal values. In the example value 30.0 corresponds to 100 Hz frequency. Values between the table points are linearly interpolated (here in the example 35.0 corresponds to frequency 150 Hz). Values outside the table are linearly extrapolated (here in the example 25.0 corresponds to 50 Hz, and 64.0 to 400 Hz).

Transmitter's characteristics are stored in the data base in the settings. To view the base contents and to add or remove characteristic table user has to choose **Characteristic manager** submenu from the main menu.



To add on a new characteristic the USB Flash Memory containing a relevant file has to be inserted. In **Characteristic manager** menu user has to press **NEW ONE** button. A list of files with .txt or .csv. extensions will be displayed and the highlighted file can be chosen with the **LOAD** button. A new characteristic can also be added during the input configuration without need of entering the characteristic database. For this purpose in **Char** submenu user should choose **From file...**. This will display a list of available files and it allows to add a characteristic table.

Pressing **REMOVE** button deletes all user's characteristics. The occupied memory volume is displayed next to the name on the list of characteristic tables. At the bottom of the screen the remaining free memory space is displayed. The database can store up to 16 characteristics.

## 4.15. Audit trials

The recorder offers three logs that include different types of measurement events and user operations: Totaliser Log, Event Log and Authorization Log. The logs are saved in the internal memory. Logs can be accessed from the display, via RS-485 port (when MPI-C-Raport software is used, Event Log and Authorized Operations Log can only be displayed) and after transferring data using USB flash drive.

### 4.15.1. Totaliser Log

Once a month the totaliser log is saved for all enabled totalisers including information about the time in which the instrument was turned on during the month. The data is Recorded on the day and the hour indicated in the settings in **Nominal month beginning**. In the log are stored 13 last records.

## 4.15.2. Event Log

In the event log are recorded:

- power supply turning on and off,
- settings change,
- date or hour change,
- resetting of maximum, minimum and average values,
- resetting of totalisers,
- beginning and the end of declared thresholds crossing,
- beginning and the end of superheated steam saturation,
- beginning and the end of declared input signal failure,
- change of state of selected binary inputs.

The date and time of each event occurrence is recorded. The device display enables to view the last 500 events. The log is also available as a text file that can be copied and read on a computer (see section 4.1.5).

In settings a user should declare which thresholds crossing are to be recorded (submenu **Event**), which analog inputs failure should be recorded and for which binary inputs shorting (closing) and opening should be recorded (submenu **Actions when failure**, **Actions when closed** and **Actions when open**).

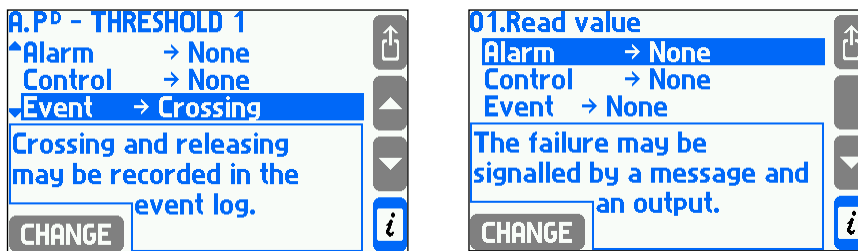

## 4.15.3. Authorization Log

In authorization log is recorded each execution of one of commands listed below but only when the respective command requires authorization (is password protected), (see section 4.6). These are:

- creation of a new main archive file,
- resumption or stopping of archive recording
- resetting of maximum, minimum and average values,
- resetting of totalisers,
- date and hour change,
- change of main settings (all except of listed below),
- change of thresholds settings (value and hysteresis value),
- change of display settings (screens configuration, backlit and contrast of display),
- change of archiving settings (recording interval, set of archived values and recording mode),
- loading of new settings from a file,
- installation new firmware.

The date and time of each authorized activity is recorded. The device display enables to view the last 500 events. The log is also available as a text file that can be copied and read on a computer (see section 4.1.5).

## 4.15.4. Logs browsing on device display

Browsing logs is available only for logged administrator. To browse logs user has to choose the **Audit trail** submenu from the main menu.

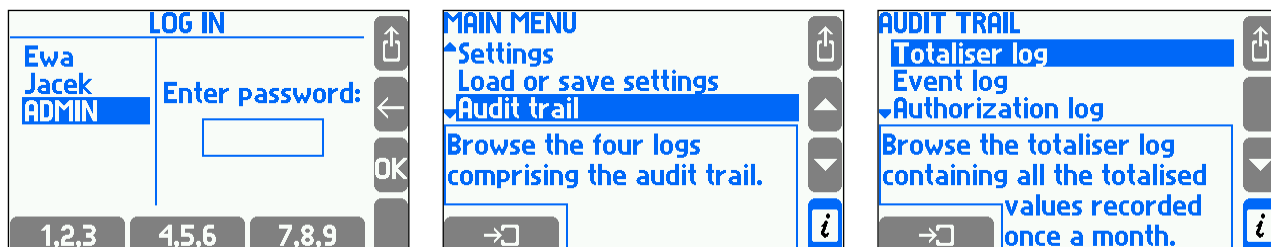

After selecting the totaliser log, the device displays a list of dates and times of available entries. The user should select the right entry and application, then device displays the symbols and states of totalisers in the list.

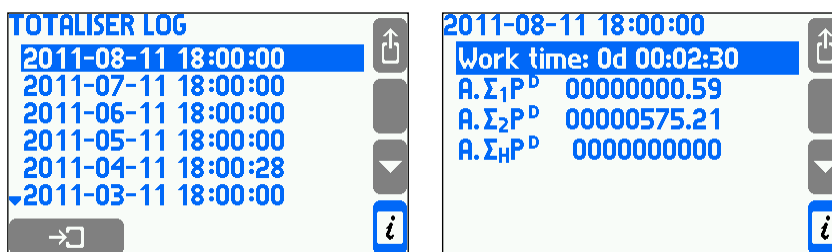

Other logs are displayed in form of a scrolled list. Each line corresponds to one record (event or action). Simultaneously on display there are visible three records. In a frame underneath, additional information about highlighted record is displayed.

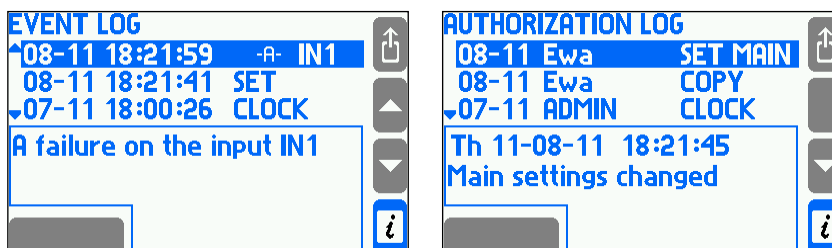

Up to 500 most recent events, 500 authorized operations and 50 calibrations can be displayed.

## 4.15.5. Event Log Files and Authorized Operations Log Files

Event Log and Authorized Operations Log files are available for users. Event Log file is called *event\_[addr].txt* and Authorized Operations Log file is called *a\_log\_[addr].txt* where *addr* means a two-digit device address.

**!** To differentiate files from different recorders, it is recommended to configure different addresses even if the RS-485 port is not used in data transmission.



Files are created automatically, and can be deleted only by the SERVICE user.

The files can be uploaded to a PC via USB flash drive(see section 4.1.5). This function can be password-protected. Data in the file are protected with check boxes to make sure that no data modification takes place outside the recorder.

### **4.15.6. Remote reading of the Log**

*The MPI-C-Raport* program allows browsing the content of the event log and the authorization log using the RS-485 port. In this way can be read records and files that are stored in an internal 2 GB data memory.





### 5. INTERNAL DATA MEMORY

The recorder has 2GB internal memory. Relatively large data volumes can be saved in the internal memory (see the Table ), i.e. up to 250 files.

Backup copies of data saved on the internal memory must be created at suitable time intervals. Files should be copied from the internal memory and saved on a PC, on recordable media (CDs, etc.) or printed on a regular basis.

The following data are stored in the internal memory:

- Main archive (archive of current results),
- Totaliser archive,
- Event Log Files and Authorized Operations Log Files.

There are three methods of data saving in the main archive: **Overwrite**, **One file**, **Successive files**. **Overwrite** means that the oldest files are overwritten, in the **One file** mode data are recorded until the file size reaches the level set in the **File size**. In the **Successive files** mode, if the recorded file size reaches the level set in the **File size**, the recording continues until the next file is automatically created.

You can set the maximum file size (**File size**) of the main archive (see Section 10.12).

Data saved on the internal data memory can be:

- uploaded to a PC via RS-485 or Ethernet port. In this configuration, the transmission rate is relatively low, and the data should be uploaded at relatively short time intervals, in smaller “portions”.
- Data files (archive files of current results, totalisers and logs) can be copied from the device to USB flash drive, and then uploaded to a PC.

*Examples of recording intervals of measurement results in the 2GB internal memory. Note! The information in the Table are provided as a reference only.*

Recording interval	3 s	10 s	30 s	1 min	5 min	10 min
16 channels	over a year	over 4 years	over 10 years	over 20 years	over 130 years	over 260 years
8 channels	over 2 years	over 7 years	over 20 years	over 40 years		
4 channels	over 3 years	over 10 years	over 30 years			
1 channel	over 4 years	over 15 years	over 40 years			



## 6. TECHNICAL DATA

Technical data are specified for both versions, MPI-D and MPI-DN together. Differences are emphasized appropriately.

<b>FRONT PANEL</b>	
Type of display:	Full color graphic TFT LCD, 272 x 480 px.
Reading field size:	43.8 mm x 77.4 mm
Indication:	3 three-color LEDs (green, yellow and red)
Keyboard:	MPI-D : Membrane, 7 buttons MPI-DN: Membrane, 19 buttons
<b>SERIAL PORT RS-485 (1)</b>	
Transmission protocol	Modbus RTU
Transmission rate	3 s, 4 s, 5 s, 6 s, 10 s, 12 s, 15 s, 30 s, 1 min
Baud rate	1.2, 2.4, 4.8, 9.6, 19.2, 38.4, 57.6, 115.2 kbps
Transmitter address space	1 ... 247
Maximum load	32 receivers / transmitters
Maximum line length	1200 m
Galvanic separation	Yes, 250 VAC / 300 VDC
Maximum differential voltage A(+) – B(-)	-8 V ... +13 V
Maximum total voltage A(+) – „ground” or B(-) – „ground”	-7 V ... +12 V
Minimal output signal from transmitter	1.5 V (with $R_0 = 54 \Omega$ )
Minimum receiver sensitivity	200 mV / $R_{IN} = 12 \text{ k}\Omega$
Minimum impedance of data transmission line	27 $\Omega$
Short-circuit / thermal protection	Yes
Internal terminating circuit	Yes (activated by shorting the pins on the terminal block / DIP-switches)
Lines derived in terminal block	A(+), B(-), GND RS, +5 V RS (max 10mA), T(+), T(-)
Wire connection	MPI-D: 6-pin screw type terminal block, max. cable diameter 1,5 mm <sup>2</sup> MPI-DN: spring type terminal block, cable diameter 0,2 mm <sup>2</sup> – 1,5 mm <sup>2</sup>
<b>HART PORT</b>	
Transmission protocol	Master type rev. 4, rev 5
Implemented features	Reading variables PV, SV, TV, FV Retrieve long address Change of short address
Multidrop mode	Yes, up to 12 devices (multidrop)
Loop power	24 VDC (max 50 mA)
Analog line 4-20mA reading	No



Wire connection	MPI-D: 3-pin screw type terminal block, max. cable diameter 1,5 mm <sup>2</sup> MPI-DN: spring type terminal block, cable diameter 0,2 mm <sup>2</sup> – 1,5 mm <sup>2</sup>
<b>PULS INPUTS</b>	
Number of inputs	2
Maximum input voltage	30 VDC lub 30 V <sub>p-p</sub>
Measurement range	0.001 Hz do 10 kHz 0.001 Hz do 1 kHz, if the filtrating capacitor is connected
Minimum pulse width	20 μs 0.5 ms, if the filtrating capacitor is connected
Accuracy (T <sub>a</sub> = 20 °C)	0.02%
Signals connection	MPI-D: two 2-pin screw type terminal blocks, max. cable diameter 1,5 mm <sup>2</sup>  MPI-DN: spring type terminal block, cable diameter 0,2 mm <sup>2</sup> – 1,5 mm <sup>2</sup>
<b>Configuration: OC / contact</b>	
Voltage(OC)	12 V
Current (contact)	12 mA
On / off treshold	2,7 V / 2,4 V
<b>Configuration: input voltage</b>	
Input resitance	Okolo 1 kΩ
On / off treshold	2,7 V / 2,4 V
Open circuit voltage	12 V (see chapter 9.8)
<b>Namur configuration</b>	
High impedancje state	0,4 mA – 1 mA
Low impedancje state	2,2 mA – 6,5 mA
<b>RELAY OUTPUTS</b>	
Number of outputs	4
Type of outputs	Solid-state relays
Maximum load current	100 mA (AC/DC)
Maximum voltage	60 V (AC/DC)
Wire connection	MPI-D: two 8-pin screw type terminal blocks, max. cable diameter 1,5 mm <sup>2</sup>  MPI-DN: spring type terminal block, cable diameter 0,2 mm <sup>2</sup> – 1,5 mm <sup>2</sup>
<b>ANALOG OUTPUT 4-20mA (optional)</b>	
Number of outputs	1
Output current range	4-20mA
Maximum voltage beetwen I- and I-	28 VDC
Loop resistance (for U <sub>loop_power</sub> = 24 V)	0 ... 500 Ω



Resolution of C/A converter	16 bit
Accuracy	0.5%
Current loop power	From the outside or from an internal power supply 24 VDC / 22 mA
Galvanic separation from power supply	400 VAC
Wire connection	MPI-D: two 3-pin screw type terminal blocks, max. cable diameter 1,5 mm <sup>2</sup> MPI-DN: spring type terminal block, cable diameter 0,2 mm <sup>2</sup> – 1,5 mm <sup>2</sup>
<b>SERIAL PORT RS-485 (2)</b>	
Transmission protocol	ASCII Modbus RTU
Baud rate	2.4, 4.8, 9.6, 19.2, 38.4, 57.6, 115.2 kbps
Parity control	Even, Odd, None
Frame	1 bit start, 8 bits data, 1 bit stop
Maximum load	32 receivers / transmitters
Maximum line length	1200 m
Maximum differential voltage A(+) – B(-)	-8 V ... +13 V
Maximum total voltage A(+) – „ground” or B(-) – „ground”	-7V ... +12 V
Minimal output signal from transmitter	1,5 V (with R <sub>0</sub> = 54 Ω)
Minimum receiver sensitivity	200 mV / R <sub>IN</sub> = 12 kΩ
Minimum impedance of data transmission line	27 Ω
Short-circuit / thermal protection	Yes
Internal terminating circuit	Yes (activated by shorting the pins on the terminal block / DIP-switches)
Lines derived in terminal block	A(+), B(-), GND RS, +5 V RS (max 10mA), T(+), T(-)
Galvanic separation	No
Wire connection	MPI-D: 6-pin screw type terminal block, max. cable diameter 1,5 mm <sup>2</sup> MPI-DN: spring type terminal block, cable diameter 0,2 mm <sup>2</sup> – 1,5 mm <sup>2</sup>
<b>USB PORT</b>	
Port socket	A socket, in accordance with USB standard
Version	USB 1.1
Protection class	IP54
Recorded format	FAT16 (within a limited functions)
Recording indication	Green-red LED on the front panel
<b>ETHERNET PORT</b>	
Transmission protocol	Modbus TCP, ICMP (ping), DHCP server, http server
Interface	10BaseT Ethernet
Data buffer	300 B



Number of connections opened simultaneously	4
Connector	RJ-45
Indication LEDs	2 built-in RJ45 socket
<b>INTERNAL DATA MEMORY</b>	
Capacity	2 GB (Flash type)
Estimated recording time for recording speed every 3s for 16 measuring channels	approximately 400 days
Recording indication	Green-red LED on the front panel
<b>POWER SUPPLY (MPI-D, MPI-DN)</b>	
Supply voltage	24 VAC (+5% / -10%) 50/60 Hz 24 VDC (15 ... 30 VDC) (any polarity)
Power consumption	6 W max (power supply 24 VDC) 6 VA max (power supply 24 VAC)
Wire connection	MPI-D: 3-pin screw type terminal block, max. cable diameter 1,5 mm <sup>2</sup> MPI-DN: spring type terminal block, cable diameter 0,2 mm <sup>2</sup> – 1,5 mm <sup>2</sup>
<b>POWER SUPPLY (only MPI-DN)</b>	
Supply voltage	100 ... 240 VAC 50/60 Hz
Power consumption	Max 10 VA
Wire connection	screw type terminal block, cable diameter 0,2 mm <sup>2</sup> – 1,5 mm <sup>2</sup>
<b>MECHANICAL DIMENSIONS – CASING (MPI-D)</b>	
Type of casing	For mounting in panels, non-flammable plastic „Noryl”
Dimensions (h x w x d)	72 mm X 144 mm X 130 mm
Dimensions for panel cut-out	138 <sup>+1</sup> mm X 68 <sup>+0,7</sup> mm
Maximum panel thickness	5 mm
Weight	approx 1,1 kg
Protection class on front panel side	IP54
Protection class on rear panel side	IP30
<b>MECHANICAL DIMENSIONS – CASING (MPI-DN)</b>	
Type of casing	Wall mounting, ABS plastic
Dimensions (h x w x d)	217 mm X 257 mm X 125 mm (without cable glands) 247 mm X 257 mm X 125 mm (with cable glands)
Weight	approx 2,1 kg
Protection class	IP54
<b>ENVIRONMENTAL CONDITIONS</b>	
Operating temperature	-20 °C ... +50 °C



Relative humidity	0 ... 75% (no steam condensation)
Storage Temperature	-30 °C ... +80 °C
Overvoltage category	OVII
Pollution degree	PD2
LVD (safety)	EN 61010-1
EMC	EMC Directive 2014/30/UE EN 61326-1:2013 Tabela 2 (Immunity) EN 55011:2009+A1:2010 Class A (Radiated and conducted emissions)
Installation location	Indoor or outdoor <sup>(1)</sup>
<sup>(1)</sup> If additional protection against atmospheric precipitation is provided (roofing), the device can be installed outdoor.	

## 7. COMPLETE DELIVERY AND ACCESSORIES

### 7.1. Content of MPI-D

- MPI-D-x multi-channel electronic recorder 1 pcs.
- Fixing clamps 2 pcs.
- Printed operating manual – short version 1 pcs.
- Operating manual on CD – full version 1 pcs.
- Warranty & calibration card 1 pcs.
- Set of terminal blocks 1 set
- Cartoon package 1 pcs.

### 7.2. Content of MPI-DN

- MPI-DN-x multi-channel electronic recorder 1 pcs.
- Power supply cable 1 pcs.
- Printed operating manual – short version 1 pcs.
- Operating manual on CD – full version 1 pcs.
- Warranty & calibration card 1 pcs.
- Set of terminal blocks 1 set
- Cartoon package 1 pcs.

### 7.3. Accessories

- Converter with galvanic isolation CONV 485USB-I (USB / RS-485)
- Service converter without galvanic isolation CONV 485USB (USB / RS-485)
- Converter CONV 485 E (Ethernet / RS-485)
- GSM module
- Software for data processing and visualization MPI-C-RAPORT
- Software for setup configuration PMU-MPI-C
- Power supply transformer, manufactured by Breve PSS 10 VA, 230 V AC / 24 V AC
- Power supply transformer, manufactured by Breve PSS 30 VA, 230 V AC / 24 V AC
- 6A/230V AC relay with LED indication designed to mount to the TS-35 profile type PI6-1P-24VAC/DC, manufactured by Relpol SA



*CONV485USB-I, CONV485USB and CONV485E convertors (Metronic AKP)*



*PSS30 230V /24V i PSS10 230V/24V transformers manufactured by BREVE and PI6-1P 24VAC/DC relay manufactured by Relpol SA (all components designed to mount to the TS-35 profile)*



*GSM module*





## 8. ENTITY LAUNCHING THE PRODUCT ON EUROPEAN UNION MARKET

Manufacturer: METRONIC AKP s.c.  
31-426 Kraków, ul. Żmujdzka 3  
Tel.: (+48) 12 312 16 80  
[www.metronic.pl](http://www.metronic.pl)

Vendor:



**Note:**



**Note:**



**Note:**

## 9. ASSEMBLY AND INSTALLATION

### 9.1. Assembly

The MPI-D recorder is designed for panel surface mounting. The device may be mounted on panels with wall thickness not less than 1 mm. Dimensions of rectangular hole needed for mounting the device in a wall panel are given in the table below.

	MPI-D
Mounting cut-out in panel – width	138 <sup>+1</sup> mm
Mounting cut-out in panel – height	68 <sup>+0,7</sup> mm
Depth of mounting	ca. 127 mm

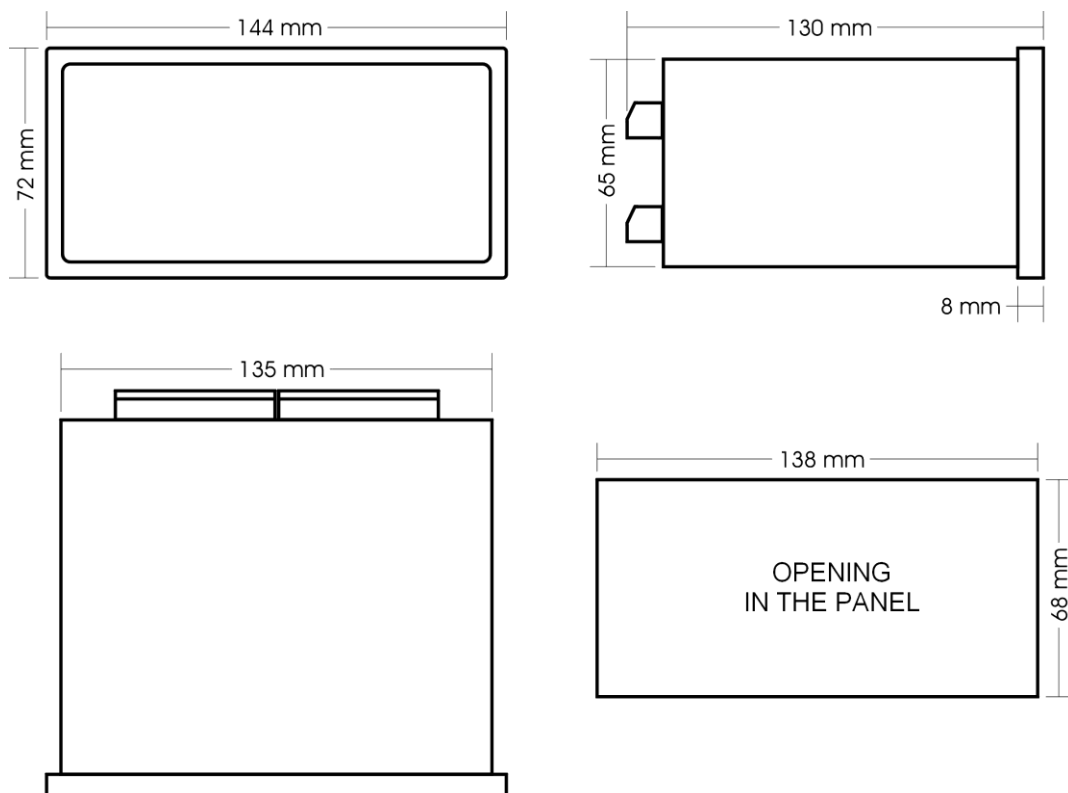

*Dimensions of housing and panel cut-out for mounting the device*

For convenient installation of electric cables it is recommended to leave about 30 mm additional space at the rear side of the device. When mounting the device a seal between panel wall and the frame should be fixed. Once embedded, the mounting brackets should be latched on its side walls and then tighten with screws. Using detachable terminals allow to the electrical installation before mounting the device.

The MPI-DN device is suitable for wall mounting. Housing dimensions without cable glands is 216 mm X 260 mm X 125 mm (height x width x depth), see section 13

**!** The devices should be mounted so as to avoid direct heating by other devices. It should be placed in a location distant from elements with high electromagnetic disturbance emission (power relays, frequency converters).



## 9.2. Electrical connections

In MPI-D device all electrical circuits are wired to the plug-in screw terminal block located on the rear panel of the device. Terminals enable connection of wires up to 1.5 mm<sup>2</sup> cross section.

In the MPI-DN all electrical terminals are located at the bottom in front of the device. The spring terminals allow to connect cables from 0,2 mm<sup>2</sup> to 1.5 mm<sup>2</sup> cross section. It is recommended to use cables with diameter as small as possible because of the need for pass a large number of cables through the cable glands.

Cables should be isolated on the section of 8 mm to 10 mm at the end. Terminals are adjusted to use cables either type of single thick wire and multiple thin wires. In case of use thicker field cabling it is necessary to apply an intermediate junction block between cables and the device.

Terminal block no.	SPECIFICATION	
1	+24V	HART port
2	I+	
3	I-	
4	+	Serial port RS-485 (1)
5	T(+)	
6	A(+)	
7	B(-)	
8	T(-)	
9	G	PULS 1
10	F+	
11	F-	PULS 2
12	F+	
13	F-	Analog output 4-20mA (optional)
14	+24V	
15	I+	
16	I-	Relay output RL1 (0,1A/60V)
17	+/~RL1	
18	-/~ RL1	Relay output RL2 (0,1A/60V)
19	+/~ RL2	
20	-/~ RL2	Relay output RL3 (0,1A/60V)
21	+/~ RL3	
22	-/~ RL3	Relay output RL4 (0,1A/60V)
23	+/~ RL4	
24	-/~ RL4	Serial port RS-485 (2)
25	+	
26	T(+)	
27	A(+)	
28	B(-)	
29	T(-)	Power supply (for MPI-D and MPI-DN)
30	G	
31	PE	
32	+/~ 24V	
33	-/~ 24V	

*MPI-D recorder terminal blocks*

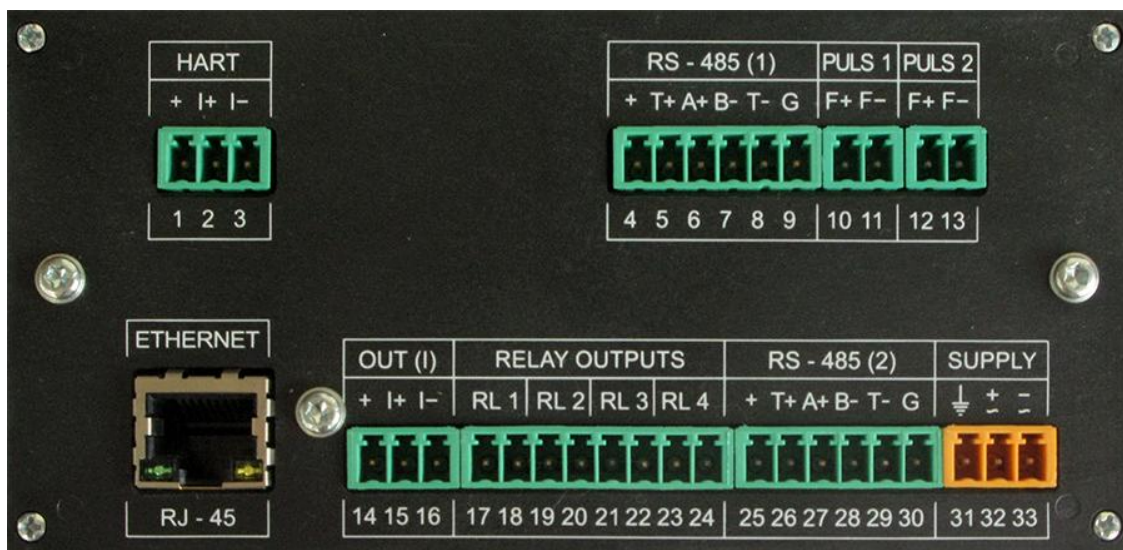

Rear panel (I/O terminal blocks)

### 9.3. Galvanic separation

## MPI-D(N)

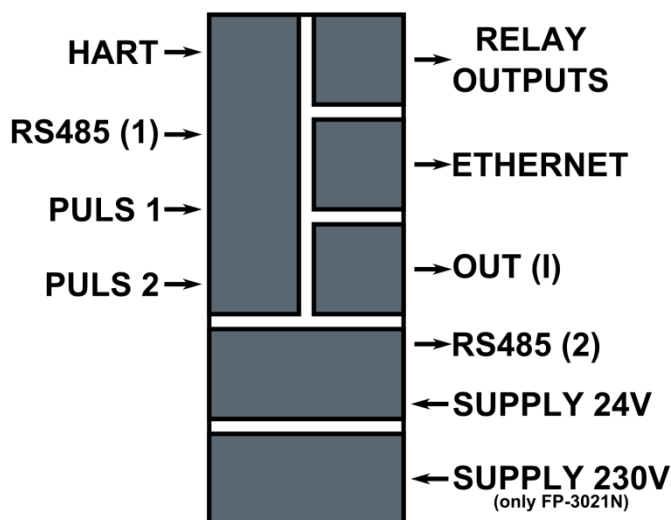

Galvanic separation in MPI-D(N)

### 9.4. Power connection

The MPI-D (MPI-DN) device power input is designed for stabilized or non-stabilized DC voltage, as well as AC voltage. It is recommended to use a separating transformer 230/24 V AC. This type of transformer is available as an accessory. In case of DC voltage polarity is of no importance.

The device is equipped with polymer fuses, which in case of emergency stop supply the power. Fuses return to initial state in a few minutes after the short circuit. Terminal no. 31 (no. 33 in MPI-DN) marked with the  $\perp$  symbol is a ground terminal. Because of EMC

distortion suppression it is recommended to connect this terminal to reference potential of cabinet (PE or „GND / 0 V”).



To ensure safety, the recorder's supply must satisfy the conditions applicable to lower voltage sources SELV (Safety Extra Low-Voltage), supplied with the 24 V DC as per the IEC60950-1.

**!** Connecting the grounding to the terminal marked with symbol  $\perp$  is recommended but not required. In specific cases where the noise level on GND is high, it may have a negative effect. In this case it is best to filter the reference potential through appropriate filters.

MPI-DN device can be also powered 230VAC (see chapter 13).

## 9.5. Connecting transmitters to the RS-485 (1) port

The RS-485(1) system is galvanically isolated from other circuits of the device. Transmission lines must be connected to terminals No. 6 and 7 (marked respectively A (+) and B (-)). On the terminal block there are also lines marked as GND (terminal No. 9) and 5 V (terminal No. 4). The GND terminal can be used i.e. to connect the reference potential or the screen of the data cable.

There is internal termination circuit inside the device. To activate it the „T+”, „A+” and „T-”, „B-” terminals should be adequately shorted. However, note that removal of the plug disconnects the resistor from the line, which in extreme cases, can prevent the transmission.

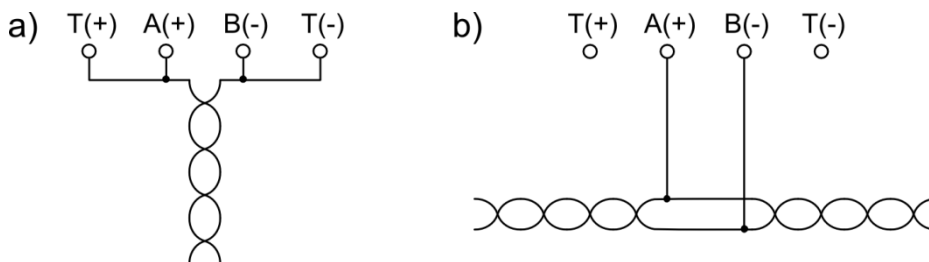

*Connection to the RS-485 bus with the device:  
when the bus is at the end of the bus using internal termination  
when device is between other equipment connected to the bus*

**!** All transmitters are connected parallel to one pair of wires. The RS-485 inputs should not create a star configuration. Devices should be connected sequentially (ends of RS-485 inputs must end with resistors matching the wave impedance). In industrial conditions strongly recommended is Twisted Pair (the best would be Shielded Twisted Pair). The screen should be grounded or connected to the reference potential at least in one end of the line. The RS-485 standard allows a connection of up to 32 devices, the maximum line length is 1200 m.



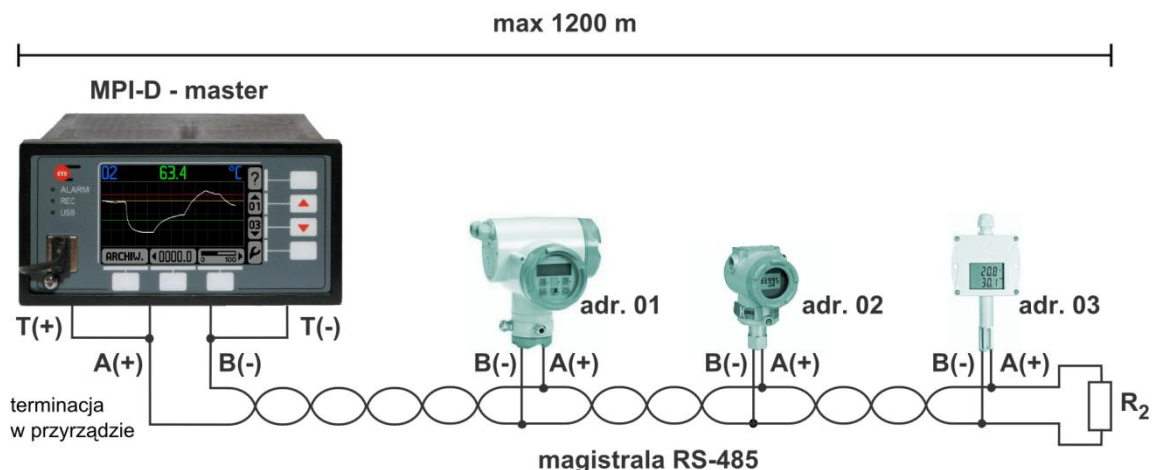

Connection of the MPI-D device and transmitters to the RS-485 bus (example)

## 9.6. Connecting transmitters to the HART port

A current loop which is used to connect the transmitters that communicate in the HART standard has to be connected to:

- terminals No. 1 (+) and No. 2 (I+) if the loop is powered by the device (24V is derived on clamp No. 1 which enables to supply the loop);
- terminals No. 3 (+) and No. 4 (I+) if the loop is to be powered from an external voltage source

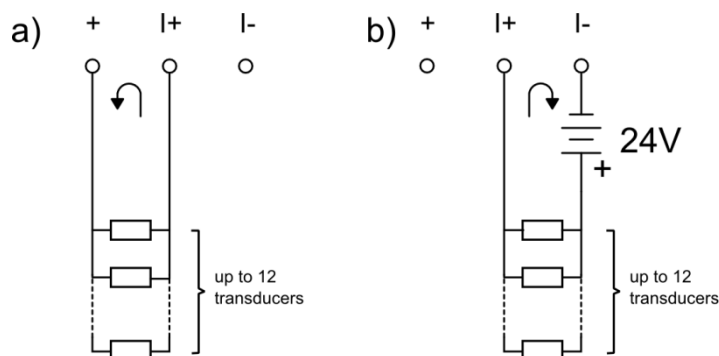

Connecting the current loop to the flow computer  
 a) loop powered by the device; b) loop powered from an external voltage source

## 9.7. Connecting the MPI-D device as Secondary Master

device can operate either as a Primary Master and Secondary Master. If the flow computer is working in Secondary Master mode, the current loop is connected in parallel to terminals No. 2 (I+) and No. 3 (I-).

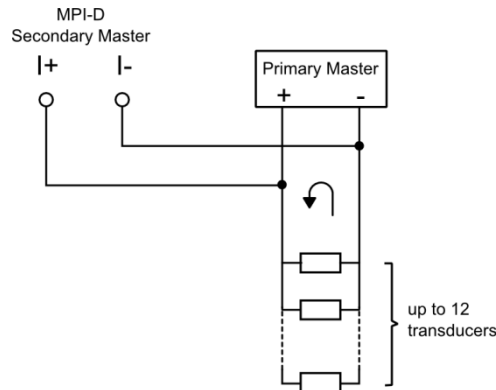

Connecting the MPI-D device as a Secondary Master

## 9.8. Connect signals to binary inputs

The MPI-D device is equipped with two PULS inputs. Typically, the flow computer is supplied in OC configuration (passive signals – the contact type or OC transistor signals). There is also a possibility to connect two other types of signals:

- active voltage signals - impedance input > 10 kΩ,
- NAMUR standard,

However, it requires changes in the hardware configuration and to do so contact the manufacturer (see section 8).

For contact-type input, the voltage is 5 VDC in disconnection state, and the current value in short-circuit state is approx. 5 mA.

For contact/OC transistor type input, the voltage in disconnection state is 12 VDC, and the current value in short-circuit state is approx. 12 mA.

For high voltage input, the activation threshold is approx. 2.7 V, and deactivation level is approx. 2,4 V. The range of the input voltage is 5 VDC – 24 VDC.

For NAMUR standard:

- sensors high impedance state is 0.4 mA – 1 mA,
- low impedance state is 2.2 mA – 6.5 mA.

**!** Digital inputs are typically configured for passive contact type signals or OC transistors. If there is a need to change the input configuration, please contact the manufacturer.

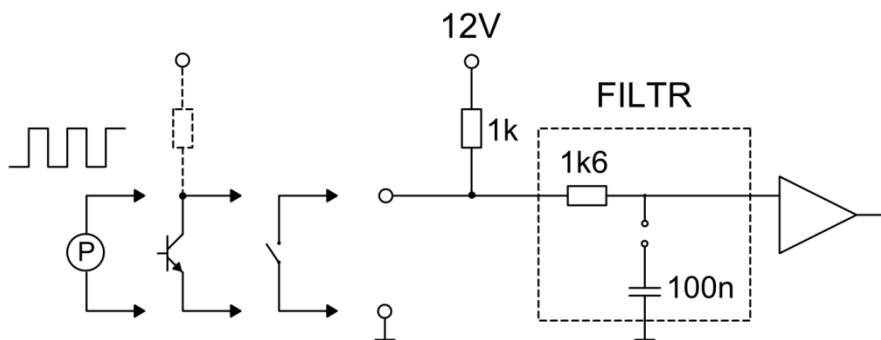

Signal forming circuit for PULS type inputs.

For low frequency signals (< 1 kHz) in particular for the contact type transmitters an additional low pass filter can be activated with a time jumper approx.. 0.1 ms.

**!** If there is a need for additional low-pass filter, please contact the manufacturer.

### 9.9. Analog output 4-20mA connection

The device can be optionally equipped with an analog current loop 4-20mA output. The current loop receiver may be connected in two ways:

- to terminal no. 14 (+) and no. 15 (I+) when the loop is supplied by the device (24V is derived on terminal no. 14, which enables to supply the loop);
- to terminal no. 15 (I+) and no. 16 (I-) when the loop is supplied from the external power supply.

The current output is galvanically separated from other circuits of the instrument.

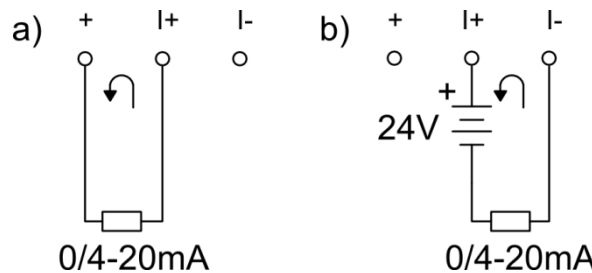

*Connection of the receiver to the analog 4-20mA output*

*a) current loop from the device, b) current loop from an external power source*

### 9.10. Connecting receivers to binary outputs (RL1 to RL4)

Solid state relays outputs are protected with capacitor (4,7 nF) and resistor (30 Ω) connected in series. It is designed to filter overvoltages suppression during inductive load switching (e.g. contactor coil). Nevertheless it is recommended to use additional inductive elements against overvoltages (e.g. protective diode, varistor).

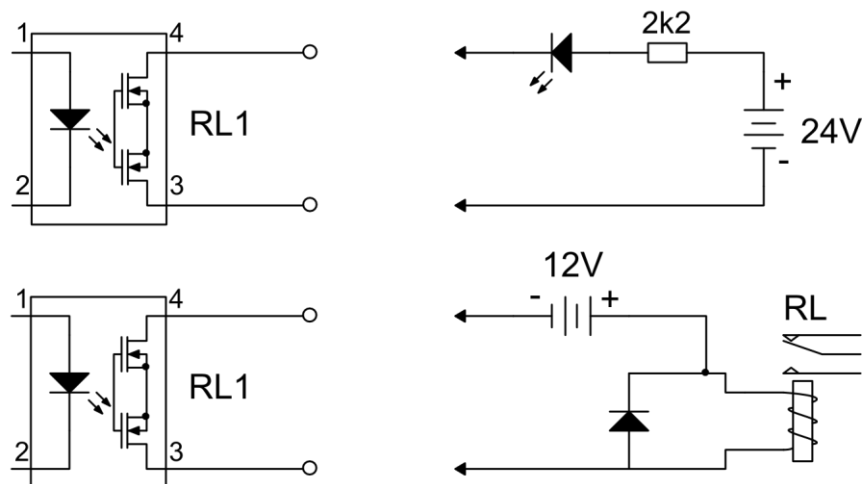

Connecting the receivers to the binary outputs

The intermediary relays should be used to control devices of higher power. In a range up to 6 A / 250 VAC it is recommended to install a relay with the LED indication (PI6-1P-24VAC/DC type) manufactured by Relpol S.A. This relay can be controlled from a DC or AC source, in particular, by the same power supply, which is used to power the device, i.e. transformer 230V/24V PSS-10's manufactured by Breve (both elements are available as additional accessories).

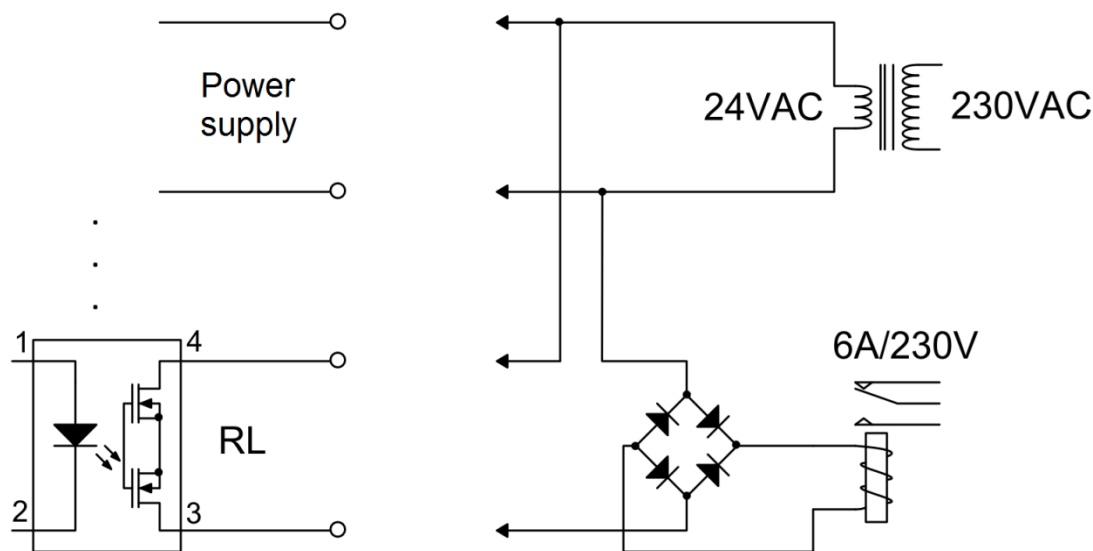

Connecting an additional external relay using transformer that supplies the device to power the relay circuit

## 9.11. Connecting to RS-485 (2) data transmission line

The device is connected to the RS-485 bus in parallel, the terminal No. 27 marked A (+) to line A and terminal No. 28 marked B (-) to line B.

In the terminal block there are additionally lines marked G (No. 30) and 5 V (No. 25). G terminal can be used to connect with the reference potential or shield of data cable.

The port has also a terminal marked with symbols “G” and “+”. The “G” terminal can be used e.g. to connect the reference potential or a screen of the data cable. To connect the terminator the following inputs must be shorted: A (+) with T(+), and B(-) with T(-). However, note that removal of the plug disconnects the resistor from the line, which in extreme cases, can prevent the transmission.

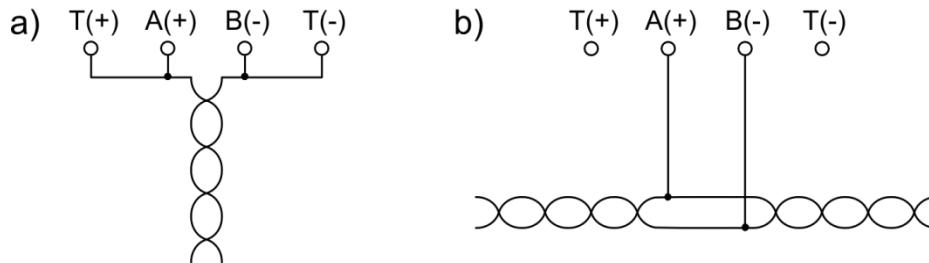

*Connection to the RS-485 bus with the device:*  
 a) when the bus is at the end of the bus using internal termination  
 b) when device is between other equipment connected to the bus

The RS-485 / RS-485(2) port is galvanically separated from other circuits of the device.

**!** The RS-485 / RS-485(2) port should not create a star configuration. Devices should be connected sequentially (ends of RS-485 inputs must end with resistors matching the wave impedance). In industrial conditions strongly recommended is Twisted Pair (the best would be Shielded Twisted Pair). The screen should be grounded or connected to the reference potential at least in one end of the line. The RS-485 standard allows a connection of up to 32 devices, the maximum line length is 1200 m. It is recommended to use a cable to digital data transmissions (e.g. for the Profibus)

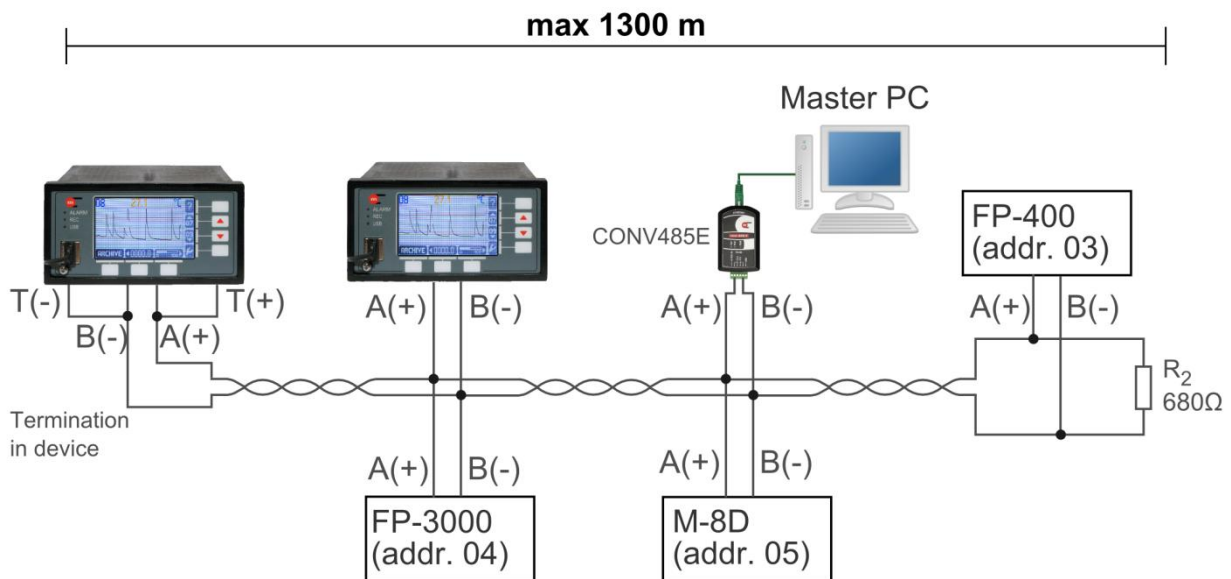

*Connecting devices to the RS-485 bus*

## 9.12. Connecting the device to the LAN using the Ethernet port

The recorder can be connected to industrial Ethernet network (LAN) using the RJ-45, located on the rear panel.

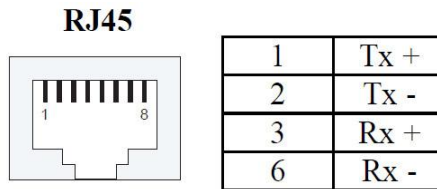

*The RJ-45 socket*

For successful communication between the device and the supervisory system it is necessary to configure all the parameters needed in the communication (see section 10.15).

## 10. DEVICE CONFIGURATION

The first configuration should be performed by the administrator (ADMIN, password: 1).

The settings defined below can be also introduced by the user.

MPI-D is a universal device that can operate in a variety of measurement systems and can handle different functions tailored to individual user needs. A new device has default settings. To customize the settings to specific measurement requirements, the recorder needs to be reconfigured. Settings are entered via keyboard or by uploading a file from USB flash drive. The file can be saved in advance on the same or another device.

All settings can be introduced by means of seven (MPI-D) or nineteen buttons (MPI-DN) and a simple user interface (selection menu shown on the display). Selected functions are displayed with a text description, and the device operation is intuitive.

The settings can be uploaded to USB flash prove plugged into USB port, and then copied to a PC. There are two files created: binary file: *SETT\_[addr].SET* and text file: *SETT\_[addr].TXT*.

**!** It is recommended to save the new settings into a file, and then to copy *SETT\_[addr].SET* and *SETT\_[addr].TXT* files to a PC or CD as back-up copies. Text files can be printed and enclosed to device records. Settings saved in *SETT\_[addr].SET* binary file can be uploaded to the recorder (or any other device with the same firmware version). When *SETT\_[addr].SET* file is uploaded, all previous settings and user / password configurations will be permanently overwritten.

### 10.1. Order of settings during configuration



Individual parameters of the device can be configured in any order; however, some settings depend on other parameters. For example, it is not possible to assign an output relay to an alarm threshold if the output is not enabled first. For this reason, the following order for the first configuration is recommended:

- relay outputs,
- transmitters,
- digital inputs (PULS inputs),
- math channels,
- sensors (transmitters) failures,
- alarms and control,
- totalisers,
- main archive,
- totalisers archive,
- display,
- RS-485 (2) port,
- Ethernet port,
- device description,
- LCD display settings
- password-protected operations,

- defining the minimum length of password,
- creating users and granting entitlements,
- changing administrator password.

## 10.2. Administrator login (ADMIN)

**!** The first setting should be introduced up by the administrator; use the administrator password: 1 to log in as an ADMIN.

After selecting  button, in **Main menu** select **Log in**, then specify the user name and enter the password. Password consists of 3 to 6 digits from 1 to 9 (without 0). To enter password combination, use the buttons at the bottom of the front panel, each digit requires a double press of a button. For example, to select the number 4 first selects a group of three digits , then the button labeled . To logout, in **Main menu** select **Log out**.

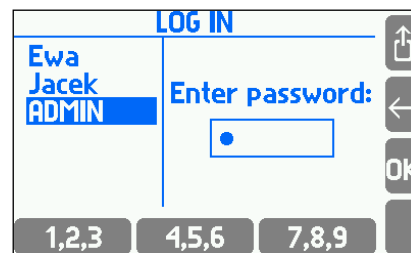

After logging into the main menu option **Log in** turns automatically into **Log out** and some additional items appear. The main menu is then as follows:





Logged-in user:

- Log out
- Archiving commands
- Copy files
- Settings
- Load or save settings
- Audit trail
- Media manager
- Characteristic manager
- Change password
- RS-485 monitor
- Change the language

Logged-in ADMIN:

- Log out
- Archiving commands
- Copy files
- Settings
- Load or save settings
- Audit trail
- Media manager
- Characteristic manager
- Change password
- Administrative data
- Test inputs and outputs
- RS-485 monitor
- Firmware and licences
- Restore factory settings
- Change the language

Only the administrator can define a protected activity, add new or delete existing users. ADMIN can also change user's password without its knowledge. The user can change only its own password. Thus the administrator password can be only disclosed to an authorized person.

Device settings can be entered in the following menus: **Settings, Administrative data, Change password:**

## SETTINGS

- Display
- Relay outputs
- Transmitters
- Digital inputs
- Math channels
- Sensors failures
- Alarms and control
- Totalisers
- Nominal month beginning
- 4-20 mA output
- Main Archive
- Totalisers Archive
- RS485 (2) port
- Ethernet port
- Text messages
- Device description...
- DST → Auto adjust (Auto adjust, Not used) <sup>[1]</sup>

## ADMINISTRATIVE DATA

- Protected commands
- Users and entitlements
- Log out after → 10 min (30sec, 1, 2, 3, 5, 10 mins) <sup>[2]</sup>
- Min pass length → 3 digs (3, 4, 5) <sup>[3]</sup>

Explanations:

[1]: „Auto adjust” means automatic winter-summer time change (recommended setting).

- [2]: Idle time; automatic user logout after idle time. Users can obviously choose to logout any time before the idle time expires.
- [3]: Minimum number of password characters.

### 10.3. Relay outputs RL1...RL4

Relay outputs can support alarm or control functions, depending on the working mode. They can also signal exceeded alarm/control thresholds and / or measurement input failures.



→ MAIN MENU → SETTINGS → RELAY OUTPUTS

#### RELAY OUTPUTS

##### Output RL1 <sup>[1]</sup>

**Type** → **Alarm** (None, Alarm, Control) <sup>[2]</sup>

**Actives** → **Closed** (Closed, Open, Pulsing) <sup>[3]</sup>

##### Output RL2 <sup>[1]</sup>

**Type** → **Control** (None, Alarm, Control) <sup>[2]</sup>

**Actives** → **Closed** (Closed, Open) <sup>[4]</sup>

##### Output RL3 <sup>[1]</sup>

**Type** → **None** (None, Alarm, Control) <sup>[2]</sup>

##### Output RL4 <sup>[1]</sup>

**Type** → **None** (None, Alarm, Control) <sup>[2]</sup>

.....

##### Output RL7 <sup>[1]</sup>

**Type** → **None** (None, Alarm, Control) <sup>[2]</sup>

##### Output RL8 <sup>[1]</sup>

**Type** → **None** (None, Alarm, Control) <sup>[2]</sup>

#### Explanations:

- [1]: Each relay output can be individually set to a suitable working mode.
- [2]: Relay output can be set to operate in a Signal or Control mode. The Signal mode means that a specific event activates the output, which needs to be confirmed by the user, even if the cause of the event subsides until then. The Signal mode is typically used to enable visual or audio signaling to indicate exceeded alarm/control thresholds. The alarm will continue until it is confirmed by pressing a button on the face plate. In the Control mode, the relay output operates as a double-status control and switches on and off when the alarm/control threshold is exceeded / returns to normal, respectively.
- [3]: **Alarm Closed** mode means that the relay circuit is closed when an event is reported (e.g. exceeded alarm/control threshold). When the alarm notification is confirmed with a button on the face plate, the relay reopens (eg. the audio signal is switched off). In the **Open** mode, the relay circuit is normally closed, and is opened when an event is reported. **Pulsing** – it repeats the ALARM LED operation on the face plate. When an event is reported, the relay circuit is closed and opened in circles at approx. 1Hz frequency (e.g. a light indicator blinks - alarm notification). After the notification is confirmed, the relay circuit remains closed if the threshold continues to be exceeded (the indicator is lit). If the threshold returns to normal – the relay circuit will be opened.

[4]: In the **Control** mode, the output relay can actively close the circle if an event occurs – **Closed** (e.g. when an alarm/control threshold is exceeded). In the **Open** mode, the relay circuit is normally closed, and is opened when an event is reported.

## 10.4. Configuration of HART and RS-485(1) inputs

Transmitters are connected to HART port or RS-485 (1) port. For HART or Modbus RTU protocol digital data is read and displayed on maximum of 18 channels.



→ MAIN MENU → SETTINGS → INPUTS → TRANSMITTERS

### RS-485 port(1) <sup>[1]</sup>

**Baud rate** → **1200** (1200, 2400, 4800, 9600, 19200, 38400, 57600, 115200) <sup>[2]</sup>

**Parity** → **Even** (Even, Odd, None) <sup>[3]</sup>

**Timeout** → **0.5 sec** (0.5, 1.0, 2.0, 5.0 secs, Enter...) <sup>[4]</sup>

**Query** → **1x** (1x, 2x, 3x) <sup>[5]</sup>

### HART port <sup>[6]</sup>

**Master** → **Primary** (Primary, Secondary) <sup>[7]</sup>

**Preamble** = **5 B** ([value]) <sup>[8]</sup>

**Update rate** → **10sek** (3, 4, 5, 6, 10, 12, 15, 30 secs, 1 min) <sup>[9]</sup>

### 01. [Read value] <sup>[10]</sup>

**Protocol** → **Modbus RTU** (Modbus RTU, HART) <sup>[11]</sup>

**Address** = **1** ([value]) <sup>[12]</sup>

**Function** → **04** (04, 03) <sup>[13]</sup>

**Register** → **0** ([value]) <sup>[14]</sup>

**Format** → **Uns.integer** (Uns.integer, Integer, Uns.long, Uns.long(sw), Long, Long(sw), Float, Float(sw)) <sup>[15]</sup>

**Multiplier** → **1** (1, 0.1, 0.01, 0.001, 0.0001) <sup>[16]</sup>

**Offset** = **0** ([value]) <sup>[17]</sup>

**Delay** → **0 ms** ([value]) <sup>[18]</sup>

**Unit** → **[None]** ([text]) <sup>[19]</sup>

**Fail value** → **None** (None, Last result, Enter...) <sup>[20]</sup>

**Tag** <sup>[21]</sup>

**Bar 100% = 100** ([value]) <sup>[22]</sup>

**Bar 0% = 0** ([value]) <sup>[22]</sup>

### 02. [ Read value] <sup>[10]</sup>

**Protocol** → **HART** (Off, Modbus RTU, HART) <sup>[23]</sup>

**Address** = **1** (Short [value], Long [value], Fetch) <sup>[24]</sup>

**Variable** → **1.(PV)** (1.(PV), 2.(SV), 3.(TV), 4.(FV)) <sup>[25]</sup>

**Unit** → **[None]** ([text]) <sup>[19]</sup>

**Fail value** → **None** (None, Last result, Enter...) <sup>[20]</sup>

**Tag** <sup>[21]</sup>

**Format** → **0000.0** (0.0000, 00.000, ..., 00000) <sup>[26]</sup>

**Bar 100% = 100** ([value]) <sup>[22]</sup>

**Bar 0% = 0** ([value]) <sup>[22]</sup>

.....

### 17. [Read value] <sup>[10]</sup>

**Protocol** → **Off** (Off, Modbus RTU, HART) <sup>[27]</sup>

### 18. [Read value] <sup>[10]</sup>

**Protocol** → **Off** (Off, Modbus RTU, HART) <sup>[27]</sup>

## Explanations:

- [1]: Submenu containing settings for the **RS-485(1)** designated for communication with the transmitters or devices.
- [2]: **Baud rate** in communication with the transmitters or devices.
- [3]: Setting **Parity** bit.
- [4]: The device after sending the read command to the transmitter or the device, waits for a response by the time set in the **Timeout**. If the instrument does not receive a response from the sensor, the read command is not sent again and the device goes to poll the next sensor or device. At the channel the device sets a failure. Pay attention to the proper selection of **Timeout**. When is set too short a queried transmitter or the device may not get answered, setting the timeout too long can result in prolongation of time to scan all channels.
- [5]: In case there is no response, the **Query** can be repeated. 1x means no repetition. Up to two repetitions are possible (3x query).
- [6]: Submenu containing settings for the **HART** communication protocol.
- [7]: MPI-D(N) device can be connected to the current loop as Primary **Master** or Secondary **Master**.
- [8]: Determine number of bytes in the **Preamble**. Select a value from 3 to 20.
- [9]: Update rate determines the time for all input values to be refreshed.  
This parameter should be chosen properly so the changes in measured values were not lost. It should also be taken under the consideration that choosing too short time may be not sufficient to read all enabled channels. This applies especially in the HART protocol communication, which enables up to three transactions per second. This means that, for example when device reads values from 12 different transmitters minimum scan time is 4 seconds. In addition, a longer scan time may be caused by connecting a second master (eg, communicator) to the loop, or a failure in one or more transmitters. If the update rate is too short to read all the channels, the displayed results will be refreshed every other (or subsequent) measurement cycle.
- [10]: The number of measuring channel with description. Description in square brackets „[ ]” corresponds to the preset channel description. The description is set in the **Tag...** menu.
- [11]: The **Protocol** selection in which user want to read the value assigned to the measuring channel. In this case, Modbus RTU protocol was selected.
- [12]: Sensor or device **Address** from which the measurement results will be read.
- [13]: Type of reading **Functions**. Available functions: 03 (Read Holding Registers) and 04 (Read Input Registers).
- [14]: Set the initial **Register's** address from which data will be read. The value must be given in decimal system.
- [15]: There are available 8 **Formats** of read results:
- unsigned integer - 2 bytes (1 register) without a sign,
  - signed integer - 2 bytes (1 register) with sign,
  - unsigned long integer - 4 bytes (2 registers) without a sign,
  - unsigned long integer swapped - 4 bytes (2 swapped registers) without a sign,
  - signed long integer - 4 bytes (2 registers) with a sign,
  - signed long integer swapped - 4 bytes (2 swapped registers) without a sign,
  - float - 4 bytes (2 registers),
  - float swapped - 4 bytes (2 swapped registers).

[16]: The **Multiplier** - this option is available for following variables type: unsigned integer, signed integer, unsigned long integer, unsigned long integer swapped, signed long integer and a signed long integer swapped.

$$[\text{displayed value}] = [\text{result read}] \times [\text{multiplier}]$$

[17]: The **Offset** - this option is available for following variables types: unsigned integer, unsigned long integer, unsigned long integer swapped.

$$[\text{displays score}] = ([\text{result read}] - [\text{offset}]) \times [\text{multiplier}]$$

[18]: For some devices an extra **Delay** time is required between transactions Query-Response. This time is added before the query. Typically it should be set to 0.

[19]: The **Unit** is only informative, as well as a description of the channel. For units of flows the last unit characters "/ s", "/ min", "/ h" are recognized as the unit of measurement of flow in the settlement, respectively second, minute and hourly. Unit marked "Hz" is treated as a "pulses / s" and "kHz" - as "1000 pulses / s".

[20]: The **Fail value** - the value displayed as a result of the measurement in case of sensor failure. User can program the emergency value as constant or it may be set as the last measured value. This function is used in advanced applications (e.g. in process control mode), and typically it is disabled.

[21]: Text description of the channel.

[22]: **Bar 100%** define upper and **Bar 0%** lower range of scale of the graphic chart (trend) and the analog line (bar graph)

[23]: The **Protocol** selection in which user wants to read the value assigned to the measuring channel. In this case, HART protocol is selected.

[24]: The HART protocol allows two ways of **Addressing** the device: short addresses (1 to 15) and long addresses (unique for each transmitter). The user is able to enter a short address, enter a long address, and automatically get the long address from the transmitter. To get a long address, user must select **Fetch** (requires to stop the scan of transmitters) and then enter a short address of a device which long address he wants to download.

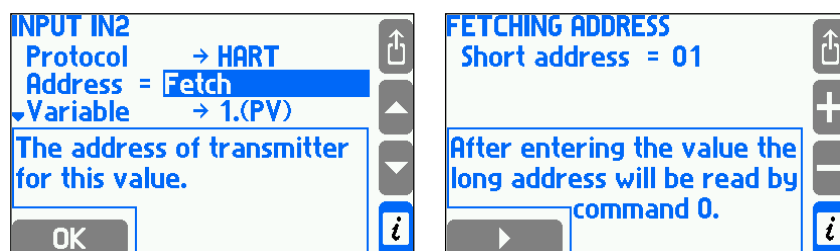

[25]: Selecting a **Variable** which user want to read:

- **1.(PV)** – primary variable,
- **2.(SV)** – secondary variable,
- **3.(TV)** – third variable,
- **4.(FV)** – fourth variable.

It is impossible to read data which the transmitter makes available outside the above-mentioned four variables.

[26]: The **Format** specifies the number of decimal places displayed in the result.

[27]: If set to **None**, the relevant measuring channel will not be displayed and measured.

## 10.5. Configuration of binary PULS type inputs

The recorder has 2 binary inputs: PULS1 and PULS2. Binary inputs can be used for:

- State monitoring
- Pulse counting
- Frequency measurementstate.

In state monitoring mode, short-circuit and opening states must be assigned numerical values. The result of the measurement is one of these values depending on the current state. In addition, for each of the states can be programmed a proper reaction of the device, similar to the alarm and control thresholds exceedances (see 10.8).

In the pulse counting mode, the instantaneous value is calculated on the basis of current frequency. The totalisers assigned to this result totalises pulses multiplied by a set rate instead of totlising subsequent instantaneous values as it is for frequency mode. In pulse counting mode the alarm-control thresholds can be used.

The PULS inputs can also measure frequency within the range of 0.001 Hz - 10 kHz. The frequency can be recalculated to a measured value according to linear characteristic or user characteristic. For linear characteristic, introduce two points, i.e. two values corresponding to two different frequencies. The measurement result can be also displayed as a measured frequency being converted into engineering units. For binary inputs in the frequency measurement mode, alarm/control thresholds can be used as well.



→ MAIN MENU → SETTINGS → DIGITAL INPUTS

### DIGITAL INPUTS

#### 19. [Tag] <sup>[1]</sup>

**Type** → **State** (State, Frequency, Pulse, None) <sup>[2]</sup>

**Unit** → **[None]** ([text]) <sup>[3]</sup>

**Closed = 1** ([value]) <sup>[4]</sup>

**Open = 0** ([value]) <sup>[5]</sup>

#### Action when closed

**Alarm** → **No** (No, Message only, RL1, ..., RL4) <sup>[6]</sup>

**Control** → **Nie** (No, RL1, ..., RL4) <sup>[7]</sup>

**Event** → **No** (No, Yes) <sup>[8]</sup>

**Swap intervals** → **No** (No, Yes) <sup>[9]</sup>

#### Action when open

**Alarm** → **No** (No, Message only, RL1, ..., RL4) <sup>[6]</sup>

**Control** → **Nie** (No, RL1, ..., RL4) <sup>[7]</sup>

**Event** → **No** (No, Yes) <sup>[8]</sup>

**Swap intervals** → **No** (No, Yes) <sup>[9]</sup>

**Tag ...** <sup>[10]</sup>

#### 20. [Tag] <sup>[1]</sup>

**Type** → **Frequency** (State, Frequency, Pulse, None) <sup>[2]</sup>

**Unit** → **[None]** ([text]) <sup>[3]</sup>

**Char** → **Linear** (Linear, [user's characteristics], From file) <sup>[11]</sup>

**0 Hz = 0** ([value] Hz = [value]) <sup>[12]</sup>

**1 Hz = 0** ([value] Hz = [value]) <sup>[12]</sup>

**Cutoff** → **None** (None, Enter...) <sup>[13]</sup>

**Tag ...** <sup>[10]</sup>

**Format** → **0000.0** (0.0000, 00.000, ..., 00000) <sup>[14]</sup>

**Bar 100% = 100.0** ([value]) <sup>[15]</sup>

**Bar 0% = 0** ([value]) <sup>[15]</sup>

Submenu appearance when selected **PULSE** type:

19. [Tag]<sup>[1]</sup>  
    **Type** → **Pulse** (State, Frequency, Pulse, None)<sup>[2]</sup>  
    **Unit** → **[None]** ([text])<sup>[3]</sup>  
    **1 imp** = 1[unit] ([value] imp. = value [unit])<sup>[16]</sup>  
    **Tag ...**<sup>[10]</sup>  
    **Format** → **0000.0** (0.0000, 00.000, ..., 00000)<sup>[14]</sup>  
    **Bar 100%** = **100.0** ([value])<sup>[15]</sup>  
    **Bar 0%** = **0** ([value])<sup>[15]</sup>

Explanations:

- [1]: The number of a measuring channel with description. Description in square brackets „[ ]” corresponds to the preset channel description. The description is set in the **Tag...** menu.
- [2]: Input operation mode: status tracing, frequency measurement or pulse counting.
- [3]: The unit and the channel description are provided for reference purposes only. In the flow measurement mode, the last characters of the unit: „/s”, „/min”, „/h” are recognized as flow measurement units in seconds / minutes / hours, respectively. „Hz” means “pulse / s”, and „kHz” – „1,000 pulses / s”.
- [4]: Numerical value is displayed (result) if the output is shorted.
- [5]: Numerical value is displayed (result) if the output is disconnected.
- [6]: A signal indicates a status change notification (shorting / disconnection) that needs to be confirmed by the user even when it subsides beforehand. Status change can be signaled with a message on the display (**Message only**) or additionally with a relay output (**RL1 – RL4**). From the four listed relays, you can only select relays pre-set as signaling relay outputs.
- [7]: Control setting to either of the listed output relays activates the selected relay when the respective status (shorting / disconnection) is present on the input.
- [8]: Status change notification (along with date and time) can be recorded in the Event Log.
- [9]: Binary inputs can control the recording process of measurement results. Two different recording intervals can be set. The selected status can switch from **Rec interval I** to **Rec interval II**. In particular, if either recording interval is set to **PAUSE**, the status on the input can cause the recording to switch on / off.
- [10]: Channel text description is provided for reference purposes only and it provides an explanation of data currently shown on the display. The description can be entered with the keyboard from the Edit menu.
- [11]: The user can select one of the user defined **characteristics** that are already in the database or select **From file...** to add another user characteristic. Added characteristic is automatically assigned to the configured input. Default characteristic is set to **Linear**.
- [12]: Selection of measuring range and method of converting the frequency of the size measured (only in the case of linear characteristic).
- [13]: This value is expressed in the units of a measurement range below which 0 is indicated. **Cut-off** can take place in flow measurements so that non-zero signal value will be indicated as an interrupted flow (indicated value = 0) in case of transducer or recorder calibration error. The cut-off value is typically set to up to 0.1% of the total range. For example: flow transducer with the total range of 0.00 - 20.00 t/h, 0.02 t/h cut-off; signal from the transducer corresponding to the range of 0.00 – 0.02 t/h is considered to equal 0.00 t/h.



- [14]: **Format** - the resolution is defined by the number of decimal places in the displayed result.
- [15]: **Bar100%** / **Bar0%** defines the upper/lower limit of the trend graph and the analog line (bar graph) range.
- [16]: The pulse weight can be set by entering the value corresponding to a defined number of pulses.

## 10.6. Math channels

Up to 16 values can be calculated as the functions of measurement results. Each calculated value is defined with a separate formula. Similarly to measurement inputs, you can also define the unit, description, display interval and bar graph range. The calculated values are indicated with 21...36 symbols.

Formulas can be entered with a special editor. The formulas can consist of:

- the results from measurement inputs (**#01**; **#02**; **#18**),
- other calculated results (**#21**; **#22**),
- constant values (**12**; **15.0**; **1.0e5**; **3.3e-7**),
- calculation symbols: addition (+), subtraction (-), multiplication (x) and division (/),
- square root symbol,
- brackets to determine the order of calculations,

The total length of all formulas can consist of up to 967 characters. The editor in the right bottom corner of the screen displays the remaining number of characters. The symbols of measurement inputs and calculation values (**#01**, **#24**) are counted as a single character.

The editor checks the correctness of the entered formula syntax and indicates errors, where appropriate (with a message displayed).

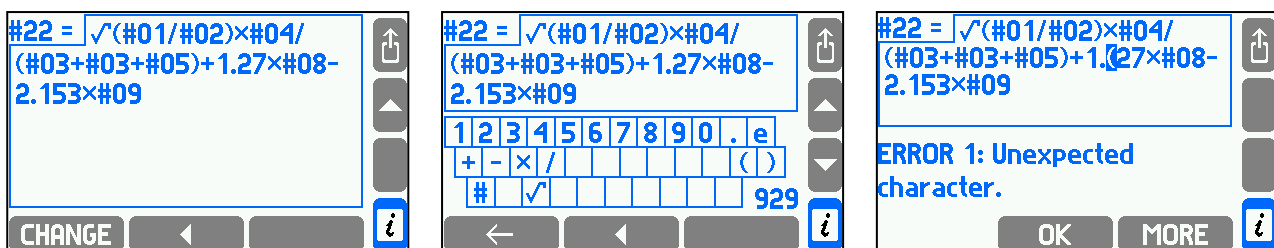

Examples of formulas:

- |   |  |
|---|--|
| <b>#01-#02</b>                                | difference between the measurement result on input 01 and the result on input 02.                        |
| <b>(#05+#06+#07+#08) / 4</b>                  | average value of measurement results on inputs 05, 06, 07 and 08.  |
| <b>(#01+#02) / (#01+#02+#03+#04+#05) x100</b> | percentage share of flows measured with inputs 01 and 02 in the total flow measured with inputs 01...05. |





→ MAIN MENU → SETTINGS → MATH CHANNELS

**MATH CHANNELS**

- 21. [Tag]<sup>[1]</sup>
  - Formula ...<sup>[2]</sup>
  - Unit → [None] ([text])<sup>[3]</sup>
  - Tag ...<sup>[4]</sup>
  - Format → 0000.0 (0.0000, 00.000, ..., 00000)<sup>[5]</sup>
  - Bar 100% = 100.0 ([value])<sup>[6]</sup>
  - Bar 0% = 0 ([value])<sup>[7]</sup>
- 22. [Tag]<sup>[1]</sup>
  - Formula ...<sup>[2]</sup>
- .....
- 36. [Tag]<sup>[1]</sup>
  - Formula ...<sup>[2]</sup>

## Explanations:

- [1]: The number of a calculated value with description. Description in square brackets „[ ]” corresponds to the preset channel description. The description is set in the **Tag...** menu.
- [2]: The **formula** that defines the calculated value. If the formula is absent, the calculated value is disabled. The remaining menu settings are not displayed.
- [3]: The **unit** and the channel description are provided for reference purposes only. In the flow measurement mode, the last characters of the unit: „/s”, „/min”, „/h” are recognized as flow measurement units in seconds / minutes / hours, respectively. „Hz” means “pulse / s”, and „kHz” – „1,000 pulses / s”.
- [4]: Channel text description is provided for reference purposes only and it provides an explanation of data currently shown on the display. The description can be entered with the keyboard from the Edit menu.
- [5]: **Format** - the resolution is defined by the number of decimal places in the displayed result.
- [6]: **Bar100%** defines the upper limit of the bar graph (trend graph) and the analog line (bar graph) range.
- [7]: **Bar0%** defines the lower limit of the bar graph (trend graph) and the analog line (bar graph) range.

**10.7. Failure signaling of measuring transducers**

Analog inputs (measuring channel 01 – 18) can detect emergency conditions of the transducer (break, shorting, exceeded threshold – depending on the input type). Depending on the configuration, emergency status can be signaled with a message on the display, alarm notification, activation of control relay or an entry in the Event Log. If relay outputs are to signal a failure, they should be preset accordingly (see Section 10.3).



→ MAIN MENU → SETTINGS → TRANSMITTERS FAILURES

**SENSORS FAILURES**

- 01.[Tag]<sup>[1]</sup>
  - Alarm → No (No, Message only., RL1, ..., RL8)<sup>[2]</sup>
  - Control → No (No, RL1, ..., RL8)<sup>[3]</sup>

**Event** → **None** (None, Both, Failure, Recovery) <sup>[4]</sup>

**Send a text** → **No** (No, Yes) <sup>[5]</sup>

02.[Tag] <sup>[1]</sup>

**Alarm** → **No** (No, Message only., RL1, .., RL8) <sup>[2]</sup>

**Control** → **No** (No, RL1, .., RL8) <sup>[3]</sup>

**Event** → **None** (None, Both, Failure, Recovery) <sup>[4]</sup>

**Send a text** → **No** (No, Yes) <sup>[5]</sup>

.....

16.[Tag] <sup>[1]</sup>

**Alarm** → **No** (No, Message only., RL1, .., RL8) <sup>[2]</sup>

**Control** → **No** (No, RL1, .., RL8) <sup>[3]</sup>

**Event** → **None** (None, Both, Failure, Recovery) <sup>[4]</sup>

**Send a text** → **No** (No, Yes) <sup>[5]</sup>

Explanations:

- [1]: Each analog input (measuring channels 01 – 18) can have an individual reaction to an alarm condition assigned. Description in square brackets „[ ]” corresponds to the preset channel description.
- [2]: A signal indicates a status change notification that needs to be confirmed by the user even when it subsides beforehand. Status change can be signaled with a message on the display (**Message only**) or additionally with a relay output (**RL1 – RL4**). From the listed relays, you can only select relays preset as signaling relay outputs. As a rule, a single relay is selected to signal a failure (RL4, etc.) and connected to an audio or light indicator, and the failure status of all channels is assigned to this single relay. If the failure signaling is set to **No**, the failure will not be signaled. This setting is not recommended although can be desirable if the measurement sensor is frequently disconnected.
- [3]: **Control** setting to either of the listed output relays activates the selected relay if any failure is detected. This setting is primarily assumed to define the recorder reaction if any measurement sensor fails during the control process. For example, if the device controls fan activation in response to exceeded temperature value limit, then if the sensor is broken, it can be defined whether the fan is to be switched on or off.
- [4]: If any failure is detected on the measurement input, the failure can be entered in the Event Log (with its date and time). Depending on the settings, the Event Log can include **Both**, **Failure** or **Recovery** type entries.
- [5]: Sending text message when failure occurs. This feature requires a GSM modem to be connected and properly configured.

## 10.8. Alarms and control thresholds

Each measuring channel can have four independent alarm/control thresholds (levels) defined. Each threshold can be set to „High” or „Low” and used for alarm signaling and / or control, or can change between the two of recording intervals. Information on exceeded thresholds can be recorded in the Event Log. Each alarm and control threshold can have a colour assigned.



→ MAIN MENU → SETTINGS → ALARMS AND CONTROL

### ALARMS AND CONTROL

01.[Tag] <sup>[1]</sup>

**Threshold 1 [▲58]** <sup>[2]</sup>  
**Tryb** → **High** (Off, High, Low) <sup>[3]</sup>  
**Level** = **58 °C** <sup>[4]</sup>  
**Hysteresis** = **0.5 °C** <sup>[5]</sup>  
**Alarm** → **No** (No, Message only., RL1, .., RL8) <sup>[6]</sup>  
**Control** → **No** (No, RL1, .., RL8) <sup>[7]</sup>  
**Event** → **None** (None, Both, Crossing., Releasing) <sup>[8]</sup>  
**Send a text** → **No** (No, Yes) <sup>[11]</sup>  
**Swap intervals** → **No** (No, Yes) <sup>[9]</sup>  
**Colour** → **Red** (No change, Green, Yellow, Red) <sup>[10]</sup>

**Threshold 2 [▼-15]** <sup>[2]</sup>  
**Tryb** → **Low** (Off, High, Low) <sup>[3]</sup>  
**Level** = **-15 °C** <sup>[4]</sup>  
**Hysteresis** = **0.2 °C** <sup>[5]</sup>  
**Alarm** → **No** (No, Message only., RL1, .., RL8) <sup>[6]</sup>  
**Control** → **No** (No, RL1, .., RL8) <sup>[7]</sup>  
**Event** → **None** (None, Both, Crossing., Releasing) <sup>[8]</sup>  
**Send a text** → **No** (No, Yes) <sup>[11]</sup>  
**Swap intervals** → **No** (No, Yes) <sup>[9]</sup>  
**Colour** → **Red** (No change, Green, Yellow, Red) <sup>[10]</sup>

**Threshold 3** <sup>[2]</sup>  
**Tryb** → **Off** (Off, High, Low) <sup>[3]</sup>

**Threshold 4** <sup>[2]</sup>  
**Tryb** → **Off** (Off, High, Low) <sup>[3]</sup>

## 02.[Tag] <sup>[1]</sup>

**Threshold 1** <sup>[2]</sup>  
**Tryb** → **Off** (Off, High, Low) <sup>[3]</sup>

**Threshold 2** <sup>[2]</sup>  
**Tryb** → **Off** (Off, High, Low) <sup>[3]</sup>

**Threshold 3** <sup>[2]</sup>  
**Tryb** → **Off** (Off, High, Low) <sup>[3]</sup>

**Threshold 4** <sup>[2]</sup>  
**Tryb** → **Off** (Off, High, Low) <sup>[3]</sup>

.....

## 36.[Tag] <sup>[1]</sup>

**Threshold 1** <sup>[2]</sup>  
**Tryb** → **Off** (Off, High, Low) <sup>[3]</sup>

**Threshold 2** <sup>[2]</sup>  
**Tryb** → **Off** (Off, High, Low) <sup>[3]</sup>

**Threshold 3** <sup>[2]</sup>  
**Tryb** → **Off** (Off, High, Low) <sup>[3]</sup>

**Threshold 4** <sup>[2]</sup>  
**Tryb** → **Off** (Off, High, Low) <sup>[3]</sup>

### Explanations:

- [1]: Each channel has four individually programmable alarm and control thresholds. Description in square brackets „[ ]” corresponds to the preset channel description.
- [2]: All pre-programmed thresholds will have an operation mode (**▲ - High**, **▼ - Low**) and the operation mode level indicated in brackets „[ ]”.
- [3]: The threshold can be set to **High** (active above a specific level) or **Low** (active below a specific level) operation mode.
- [4]: The threshold level value is entered in the measured value units assigned to a specific measuring channel. The unit (°C, etc.) is entered automatically.

- [5]: The hysteresis value is the difference between the threshold value exceedance and return to normal. The threshold hysteresis value is entered in the measured value units assigned to a specific measuring channel. The unit (°C, etc.) is assigned automatically. For example, for a threshold set to **High**, 58 °C threshold level and 0.5 °C hysteresis means that the threshold will be exceeded above 58 °C, and will return to normal below 57.5 °C (58-0.5). For a threshold set to **Low**, -15 °C threshold level and 0.2°C hysteresis means the threshold will be exceeded below -15 °C, and will return to normal above -14.8 °C (-15-0.2)).
- [6]: The same as for failure signaling. A signal indicates an exceeded threshold notification that needs to be confirmed by the user even when it subsides beforehand. Exceeded threshold can be signaled with a message on the display (**Message only**) or additionally with a relay output (**RL1 - RL8**). From the listed relays, you can only select relays preset as signaling relay outputs. In a typical application, alarm signaling is arranged by grouping exceeded thresholds from different channels to a single or several relays.
- [7]: Control setting to either of the listed output relays activates the selected relay if any alarm and control threshold is exceeded. Select appropriate threshold and hysteresis values to support simple binary on/ off control operations. For example, when a ventilator is connected to a correctly preset output relay and when the **High** threshold is set to 50 °C with 8 °C hysteresis, the fan will be switched on and off when the temperature level is above 50 °C or below 42 °C, respectively.
- [8]: The same as for failure signaling, exceeded threshold notification (along with its date and time) can be recorded in the Event Log. Depending on the settings, the Event Log can include **Both**, **Crossing** or **Releasing** entry type.
- [9]: The recording of measurement results can be controlled by means of exceeded alarm/control thresholds. Two different recording intervals can be set. The exceeded threshold can switched from **Rec interval I** to **Rec interval II**. In particular, if either recording interval is set to **PAUSE**, the recording can be switched on / off when the threshold (or several thresholds from different channels) is exceeded.
- [10]: In addition, each alarm/control threshold can have a color (green - low priority, yellow, red – high priority) assigned. If the threshold is exceeded, the result is displayed in a different color. If the threshold is exceeded more than once, the highest priority color is displayed.
- [11]: Sending text message when failure occurs. This feature requires a GSM modem to be connected and properly configured.

## 10.9. Totalisers

One or two totalisers can be used for each measurement output and calculated value with a flow unit. The flow unit needs to be entered as: „.../s”, „.../min”, „.../h”, „Hz” or „kHz”. The totaliser unit is created automatically by deleting the ending, i.e. if the totaled quantity is expressed in „kg/h”, the totaliser unit will be „kg”; if the total quantity is expressed in „Hz” or „kHz”, the totaliser has no unit assigned.

Each enabled totaliser is updated every 1 second according to the instantaneous value of the totaled quantity. The conversion factor is selected automatically based on the applicable unit. Example: if the totaled instantaneous value is 180 kg/h, 0.05 kg is added every second to the totaliser. The value added to the totaliser can be both, positive and negative.

Totaliser update for binary inputs operating in the frequency measurement mode is somewhat different. The totaliser value is increased / decreased every 1 second as well, but according to the number of pulses recorded within the last second. Example: water mass flow is measured with a pulse water meter. The water meter is connected to a binary input set to the pulse counting mode. The pulse weight is 10 dm<sup>3</sup>. At a specific speed of the water meter, subsequent pulses arrive every 20 seconds, and the frequency equals 0.05 Hz. Instantaneous value of the mass flow is 0.5 dm<sup>3</sup>/s. The instantaneous value is not totaled by the totalisers (if assigned to the input), but instead the totalisers increase their status by 10 dm<sup>3</sup> every 20 seconds, with each incoming pulse.



→ MAIN MENU → SETTINGS → TOTALISERS

## TOTALISERS

01.[Tag]<sup>[1]</sup>

### Totaliser Σ1

**Mode** → Totalise (Off, Totalise, Modbus RTU, HART)<sup>[2]</sup>

**Format** → 0000.0 (0.0000, 00.000, ..., 00000)<sup>[3]</sup>

### Totaliser Σ2

**Mode** → Off (Off, Totalise, Modbus RTU, HART)<sup>[2]</sup>

02.[Tag]<sup>[1]</sup>

### Totaliser Σ1

**Mode** → Modbus RTU (Off, Totalise, Modbus RTU, HART)<sup>[2]</sup>

**Address** = 1 ([value])<sup>[3]</sup>

**Function** → 04 (04, 03)<sup>[4]</sup>

**Register** → 0 ([value])<sup>[5]</sup>

**Format** → Uns.integer (Uns.integer, Integer, Uns.long, Uns.long(sw), Long, Long(sw), Float, Float(sw))<sup>[6]</sup>

**Multiplier** → 1 (1, 0.1, 0.01, 0.001, 0.0001)<sup>[7]</sup>

**Delay** → 0 ms ([value])<sup>[8]</sup>

**Unit** → [None] ([text])<sup>[9]</sup>

### Totaliser Σ2

**Mode** → Off (Off, Totalise, Modbus RTU, HART)<sup>[2]</sup>

03.[Tag]<sup>[1]</sup>

### Totaliser Σ1

**Mode** → HART (Off, Totalise, Modbus RTU, HART)<sup>[2]</sup>

**Address** = 1 (Short [value], Long [value], Fetch)<sup>[10]</sup>

**Variable** → 1.(PV) (1.(PV), 2.(SV), 3.(TV), 4.(FV))<sup>[11]</sup>

**Format** → 0000.0 (0.0000, 00.000, ..., 00000)<sup>[12]</sup>

### Totaliser Σ2

**Mode** → Off (Off, Totalise, Modbus RTU, HART)<sup>[2]</sup>

.....

36.[Tag]<sup>[1]</sup>

### Totaliser Σ1

**Mode** → Off (Off, Totalise, Modbus RTU, HART)<sup>[2]</sup>

### Totaliser Σ2

**Mode** → Off (Off, Totalise, Modbus RTU, HART)<sup>[2]</sup>

## Explanations:

[1]: There are two independent totalisers available for each channel (measurement input or calculated value). The Totalisers menu include no channels that are disabled or set to °C (that measure or calculate temperature). The tag of the totaliser is the same as the tag of the channel for which the totaliser is set.

- [2]: Protocol selection in which the totaliser will work. Please specify whether the totaliser is to be calculated by the recorder instantaneous reading (Accrual) or read from the device / transmitter Modbus RTU protocol or HART protocol.
- [3]: Sensor or device **Address** from which the measurement results will be read.
- [4]: Type of reading **Functions**. Available functions: 03 (Read Holding Registers) and 04 (Read Input Registers).
- [5]: Set the initial **Register's** address from which data will be read. The value must be given in decimal system.
- [6]: There are available 8 **Formats** of read results:
  - unsigned integer - 2 bytes (1 register) without a sign,
  - signed integer - 2 bytes (1 register) with sign,
  - unsigned long integer - 4 bytes (2 registers) without a sign,
  - unsigned long integer swapped - 4 bytes (2 swapped registers) without a sign,
  - signed long integer - 4 bytes (2 registers) with a sign,
  - signed long integer swapped - 4 bytes (2 swapped registers) without a sign,
  - float - 4 bytes (2 registers),
  - float swapped - 4 bytes (2 swapped registers).
- [7]: The **Multiplier** - this option is available for following variables type: unsigned integer, signed integer, unsigned long integer, unsigned long integer swapped, signed long integer and a signed long integer swapped.

$$[\text{displayed value}] = [\text{result read}] \times [\text{multiplier}]$$

- [8]: For some devices an extra **Delay** time is required between transactions Query-Response. This time is added before the query. Typically it should be set to 0.
- [9]: The totaliser **Unit**.
- [10]: The HART protocol allows two ways of **Addressing** the device: short addresses (1 to 15) and long addresses (unique for each transmitter). The user is able to enter a short address, enter a long address, and automatically get the long address from the transmitter. To get a long address, user must select **Fetch** (requires to stop the scan of transmitters) and then enter a short address of a device which long address he wants to download.

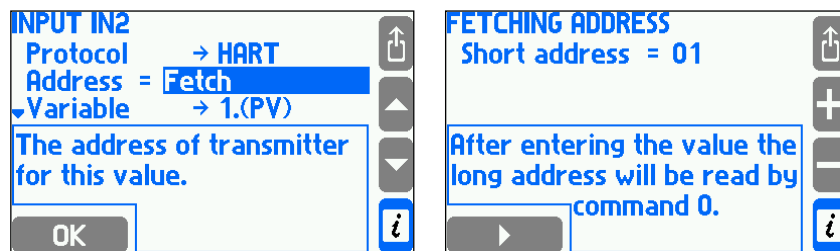

- [11]: Selecting a **Variable** which user want to read:
  - **1.(PV)** – primary variable,
  - **2.(SV)** – secondary variable,
  - **3.(TV)** – third variable,
  - **4.(FV)** – fourth variable.

It is impossible to read data which the transmitter makes available outside the above-mentioned four variables.

- [12]: The **Format** specifies the number of decimal places displayed in the result.

### 10.10. Nominal month beginning

This option applies to the periodically resetting totalisers and the monthly register ed totaliser log. Specifies the contractual beginning of the month as any full hour on any day of the month between 1 and 28 or the last day of the month.



→ MAIN MENU → SETTINGS → NOMINAL MONTH BEGINNING

Day = 1 ([value])

Hour = 0 ([value])

### 10.11. 4-20mA current loop output (optional)



→ MAIN MENU → SETTINGS → 4-20mA OUTPUT

Value → 01 (None, 01 ... 36) <sup>[1]</sup>

4mA = 0 m<sup>3</sup>/h ([value]) <sup>[2]</sup>

20mA = 100 m<sup>3</sup>/h ([value]) <sup>[3]</sup>

Fail value → None (None, Enter...) <sup>[4]</sup>

Explanations:

- [1]: Enter the channel number (both measured or calculated in math channel), which will be retransmitted in the form of 4-20mA signal (available only active channels). Choose **None** to disable the 4-20mA output.  
The value of the current is always in the range from 3.6 mA to 22 mA. If the instantaneous value corresponds to the current lower than 3.6 mA, then the output will generate a current equal to 3.6 mA, and similarly, if the value exceeds the corresponding 22 mA, it will be generated current equal to 22mA
- [2]: Enter a value corresponding to the current of 4 mA. Unit (eg ° C, m<sup>3</sup> / h) is entered automatically appropriately to the unit of the measured value of the measuring channel.
- [3]: Enter a value corresponding to the current of 4 mA. Unit (eg ° C, m<sup>3</sup> / h) is entered automatically appropriately to the unit of the measured value of the measuring channel.
- [4]: If the result has no value (for example, during the transmitter failure), the output can generate a specific current value to indicate such situation. User may enter this value in Fail value option (value must be in the range from 3.6 mA to 22 mA).

### 10.12. Archiving of the results in the internal memory.

Select channel to be recorded, set the recording interval and mode (continuous or until the memory is full). The recorder can operate at two different recording intervals (I and II) and can be controlled by exceeded pre-programmed alarm/control thresholds or changes in the binary input status (see Section 10.5 and 10.8).



→ MAIN MENU → SETTINGS → MAIN ARCHIVE

#### MAIN ARCHIVE

Rec interval I → 10 secs (PAUSE, 3, 4, 5, 6, 10, 12, 15, 20, 30secs, 1, 2, 3, 4, 5, 6, 10, 12, 15, 20, 30mins, 1, 2, 3, 4, 6, 8, 12, 24h) <sup>[1]</sup>





**Rec interval II → 10 secs** (PAUSE, 3, 4, 5, 6, 10, 12, 15, 20, 30secs, 1, 2, 3, 4, 5, 6, 10, 12, 15, 20, 30mins, 1, 2, 3, 4, 6, 8, 12, 24h)<sup>[2]</sup>

**Archived process values**<sup>[3]</sup>

01	02	03	04	05	06	07	08
09	10	11	12	13	14	15	16
17	18	19	20				
21	22	23	24	25	26	27	28
29	30	31	32	33	34	35	36

**Mode → Successive files** (Successive files, One file, Overwrite)<sup>[4]</sup>

**File size → Entire memory** (Entire memory, 2 MB, 4 MB, 8 MB, 16 MB, 32 MB, 64 MB, 128 MB, 256 MB, 24H, Week, Month)<sup>[5]</sup>

Explanations:

- [1]: The basic recording interval (I). Recording interval should correspond to the measurement process. If the recording interval is too short, the large data volumes will make it difficult to analyze the results. If the recording interval is too long, rapid changes in the measured values cannot be identified. If the recording is set to **PAUSE**, the recording will not take place even if the recording function is switched on. **PAUSE** settings can be preferably used for the second recording interval (II). The recording will be then normally paused, and the results will be recorded only if an alarm/control threshold is exceeded.
- [2]: The second recording interval (II) is used when the recording is controlled by exceeded alarm/control thresholds (see Section 10.8). If this function is not typically used, set the interval to **PAUSE**. Other intervals can affect the time scale settings when the recorded results are displayed.
- [3]: Select channels in the table that are to be recorded.
- [4]: Results can be recorded in a **One file** mode, i.e. it will be discontinued when the file size reaches the level set in **File size**. In the **Successive files**, if the recorded file size reaches the volume set in the **File size**, the recording continues until the next file is created automatically. **Overwrite** mode means that the oldest files will be overwritten.
- [5]: The archive file size can be limited. The file size limit makes it easier to process the files on a PC.

### 10.13. Totalisers Archive

Totalisers are archived every 15 minutes.



→ MAIN MENU → SETTINGS → TOTALISERS ARCHIVE

#### TOTALISERS ARCHIVE

**Archived totalisers**<sup>[1]</sup>

$\Sigma_{101}$	$\Sigma_{201}$	$\Sigma_{102}$	$\Sigma_{202}$
$\Sigma_{103}$	$\Sigma_{203}$	$\Sigma_{104}$	$\Sigma_{204}$
$\Sigma_{105}$	$\Sigma_{205}$	$\Sigma_{106}$	$\Sigma_{206}$
$\Sigma_{107}$	$\Sigma_{207}$	$\Sigma_{108}$	$\Sigma_{208}$
$\Sigma_{109}$	$\Sigma_{209}$	$\Sigma_{110}$	$\Sigma_{210}$
$\Sigma_{111}$	$\Sigma_{211}$	$\Sigma_{112}$	$\Sigma_{212}$
$\Sigma_{113}$	$\Sigma_{213}$	$\Sigma_{114}$	$\Sigma_{214}$
$\Sigma_{115}$	$\Sigma_{215}$	$\Sigma_{116}$	$\Sigma_{216}$
$\Sigma_{117}$	$\Sigma_{217}$	$\Sigma_{118}$	$\Sigma_{218}$



$\Sigma_{119}$	$\Sigma_{219}$	$\Sigma_{120}$	$\Sigma_{220}$
$\Sigma_{121}$	$\Sigma_{221}$	$\Sigma_{122}$	$\Sigma_{222}$
$\Sigma_{123}$	$\Sigma_{223}$	$\Sigma_{124}$	$\Sigma_{224}$
$\Sigma_{125}$	$\Sigma_{225}$	$\Sigma_{126}$	$\Sigma_{226}$
$\Sigma_{127}$	$\Sigma_{227}$	$\Sigma_{128}$	$\Sigma_{228}$
$\Sigma_{129}$	$\Sigma_{229}$	$\Sigma_{130}$	$\Sigma_{230}$
$\Sigma_{131}$	$\Sigma_{231}$	$\Sigma_{132}$	$\Sigma_{232}$
$\Sigma_{133}$	$\Sigma_{233}$	$\Sigma_{134}$	$\Sigma_{234}$
$\Sigma_{135}$	$\Sigma_{235}$	$\Sigma_{136}$	$\Sigma_{236}$

Explanations:

- [1]: Select totalisers in the table that are to be recorded. If a selected totaliser is unavailable (no totalisers defined for a specific channel), it will be crossed out.

## 10.14. RS-485 port (2)

To connect the device with a PC it is essential to set the same transmission parameters in the RS-485 port (2) settings and PC, otherwise the communication will fail.



→ MAIN MENU → SETTINGS → RS485 PORT

### RS-485 PORT (2)

- Protocol** → ASCII (ASCII, Modbus RTU, GSM) <sup>[1]</sup>
- Device ID** = 1 (0, 1, ..., 99) <sup>[2]</sup>
- Baud rate** → 115200 (1200, 2400, 4800, 9600, 19200, 38400, 57600, 115200) <sup>[3]</sup>
- Parity** → EVEN (NONE, EVEN, ODD) <sup>[4]</sup>
- CRC7 check** → Yes (No, Yes) <sup>[5]</sup>
- Min delay** → 50 ms (10, 20, 30, 50, 70, 100, 150, 200, 300, 400) <sup>[6]</sup>
- Max delay** → 700 ms (500, 600, 700, 800, 1000) <sup>[7]</sup>

Explanations:

- [1]: Select the operation protocol. ASCII protocol communicates with MPI-C-Raport software. Modbus RTU is a standard protocol that can communicate with universal visualization software. GSM protocol communicates with GSM module.
- [2]: In RS-485 standard, up to 32 transmitters / receivers can be connected to the data transmission line. Each slave-type device must have a different address assigned.
- [3]: Transmission speed should be set to the highest value. For high distances or high interference level, it might be needed to decrease data transmission speed. Low transmission speed extends the reading time of the results saved in the internal memory, which is particularly noticeable when the archive files are processed.
- [4]: Parity control of each bite. It is recommended to set it to **EVEN** or **ODD** mode.
- [5]: This setting applies to the ASCII mode only. CRC control – each string of characters that is sent or received by the recorder has a byte of the CRC checksum. If the PC software doesn't calculate the CRC checksum, this particular parameter should be set to **No**. The recorder then ignores the checksum value (although it calculates and sends it in the response).
- [6]: Minimum delay is the delay of responses (the recorder will send the requested data no sooner than after the minimum delay time). As a rule, the min. delay time should be set to 50 ms in applications for MS Win 98SE / XP. In radio modems and other special data transmission instruments, it might be needed a different value.

- [7]: This setting applies to the ASCII mode only. The maximum delay is the time by which a response must be sent by the recorder. The maximum delay should be typically set to 700 ms. As a rule, the recorder “responds” immediately after the minimum delay, but sometimes the processor can support the other tasks with higher priority than data transmission. If the maximum delay is too long, the PC’s maximum timeout can be exceeded.

### 10.15. Text messages



→ MAIN MENU → SETTINGS → TEXT MESSAGES

#### TEXT MESSAGES

**PIN** → None / Enter...<sup>[1]</sup>

**Mobile numbers**<sup>[2]</sup>

**Unknown numbers** → No / Yes<sup>[3]</sup>

**Combine** → No / Yes<sup>[4]</sup>

**Header** → No / Yes<sup>[5]</sup>

**Report**<sup>[6]</sup>

**Process values to be sent**<sup>[7]</sup>

**Totalisers to be sent**<sup>[8]</sup>

**Send** → On request / Daily / Weekly / Monthly<sup>[9]</sup>

- [1]: The PIN code should be entered only if the SIM card installed in the GSM module is protected by the PIN code.

- [2]: The phone numbers list (max 3) which will be sent the notifications of alarms, failures and periodic reports.

**NEW ONE** - addition of the new phone number

**REMOVE** - deletion the item from the list

**TEST** - sending selected phone number (currently highlighted) a test SMS

- [3]: If the option **Unknown numbers** is marked as **No**, the incoming queries from beyond the configured in the device list of phone numbers will be ignored.

- [4]: If the option **Combine** is marked as **Yes** the simultaneous events will be combined in a single message.

- [5]: If the option **Header** is marked as **Yes** the header, which is consist with symbol, version and description of the device, will be attached to the message.

- [6]: The submenu to configure the content and frequency of sending text messages with current process values and totalisers.

- [7]: In the table the arrows are used to add ( **ADD ON** ) and remove ( **REMOVE** ) chosen current process values in the sent SMS.

- [8]: In the table the arrows are used to add ( **ADD ON** ) and remove ( **REMOVE** ) chosen totalisers in the sent SMS.

- [9]: If the option **On request** will be chosen the reports will be sent only as a response to the request from the user (a text message with the text "Report"). Otherwise the reports will be sent periodically, accordingly: daily (the hour which the SMS will be sent on should be specified), weekly (the hour and the day of week which the SMS will be sent on should be specified) and monthly (the hour and the day of month which the SMS will be sent on should be specified).

### 10.16. Ethernet Port

Configuration of the Ethernet port parameters.



→ MAIN MENU → SETTINGS → ETHERNET PORT

**ETHERNET PORT**

**IP** → 1.0.0.1 <sup>[1]</sup>  
**Port** = 502 <sup>[2]</sup>  
**Mask** → 255.255.255.0 <sup>[1]</sup>  
**Gate** → 1.0.0.1 <sup>[1]</sup>  
**DHCP server** → Off (Off, On) <sup>[3]</sup>  
**Timeout** = 60 secs <sup>[4]</sup>

- [1]: These parameters should correspond to the network where the recorder is intended to operate.
- [2]: It is recommended to use the 502 port dedicated to Modbus TCP.
- [3]: Switch the DHCP server off.
- [4]: Connection timeout defines the maximum time without data exchange between the master device and the recorder. If this time has lapsed, the connection is closed automatically (it is found inactive due to emergency deactivation of the master device, etc.)

**10.17. Display configuration**

The configuration of displaying the results is placed on the first item in **Settings** menu to allow possibly quick and easy way to change this settings during normal operation of the device. When the recorder parameters are set for the first time, it is recommended to perform this operation at the end of the configuration procedure.

The results displaying mode should be customized to specific user requirements and needs. Users are offered numerous results display functions and options. It is at times unreasonable to make all the display options available in order to keep the recorder operation simple. It is therefore recommended to analyze the measurement needs and to limit the results displaying options.



→ MAIN MENU → SETTINGS → DISPLAY

**DISPLAY****INDIVIDUAL SCREENS**

**Auto interval** → 2 secs (0.7, 1, 1.5, 2, 3, 4, 5) <sup>[1]</sup>  
**01.[Tag]** <sup>[2]</sup>  
**Auto-browse** → Yes (Yes, No) <sup>[3]</sup>  
**Large digits** → Primary (Primary, Visible, Hidden) <sup>[4]</sup>  
**Trend graph** → Visible (Primary, Visible, Hidden) <sup>[4]</sup>  
**Bar graph** → Visible (Primary, Visible, Hidden) <sup>[4]</sup>  
**Totalisers 1, 2** → Visible (Primary, Visible, Hidden) <sup>[4]</sup>  
**Min, max** → Visible (Primary, Visible, Hidden) <sup>[4]</sup>  
**Min, max (bar)** → Visible (Primary, Visible, Hidden) <sup>[4]</sup>  
.....  
**36.[Tag]** <sup>[2]</sup>  
**Auto-browse** → Yes (Yes, No) <sup>[3]</sup>  
**Large digits** → Primary (Primary, Visible, Hidden) <sup>[4]</sup>  
**Trend graph** → Visible (Primary, Visible, Hidden) <sup>[4]</sup>  
**Bar graph** → Visible (Primary, Visible, Hidden) <sup>[4]</sup>  
**Totalisers 1, 2** → Visible (Primary, Visible, Hidden) <sup>[4]</sup>

**Min, max** → **Visible** (Primary, Visible, Hidden) <sup>[4]</sup>

**Min, max (bar)** → **Visible** (Primary, Visible, Hidden) <sup>[4]</sup>

## SUMMARY SCREENS

Table 1

**Auto-browse** → **Yes** (Yes, No) <sup>[3]</sup>

**Print** → **Large** (Large, Small) <sup>[5]</sup>

**Row 1** → **Empty** (01, 02 ... 36) <sup>[6]</sup>

**Row 2** → **Empty** (01, 02 ... 36) <sup>[6]</sup>

**Row 3** → **Empty** (01, 02 ... 36) <sup>[6]</sup>

Table tag...

...

Table 6

**Auto-browse** → **Yes** (Yes, No) <sup>[3]</sup>

**Print** → **Small** (Large, Small) <sup>[5]</sup>

**Row 1** → **Empty** (01, 02 ... 36) <sup>[6]</sup>

...

**Row 6** → **Empty** (01, 02 ... 36) <sup>[6]</sup>

Table tag...

## SPECIAL SCREENS

**Table** → **Visible (Visible, Hidden)** <sup>[7]</sup>

**Bar chart** → **Visible (Visible, Hidden)** <sup>[7]</sup>

**Thresholds** → **Visible (Visible, Hidden)** <sup>[7]</sup>

**Relay outputs** → **Visible (Visible, Hidden)** <sup>[7]</sup>

**Date and time** → **Visible (Visible, Hidden)** <sup>[7]</sup>

**Main archive** → **Visible (Visible, Hidden)** <sup>[7]</sup>

## LCD DISPLAY

**Background colour** → **White** (Black, White) <sup>[8]</sup>

**Backlight** → **3 mins** (1, 2, 3, 5, 7, 10 mins, still ON) <sup>[9]</sup>

**Backlight brightness** = **90%** (50, 55 ... 100%) <sup>[10]</sup>

**Dimmed backlight** = **35%** (0, 5 ... 45%) <sup>[11]</sup>

## Explanations:

- [1]: To display the measurement results in a sequence, press and hold „▲” or „▼” button. Display time in the „auto” mode defines the display time of each result. This setting can be customized according to individual user preferences.
- [2]: The results displaying mode can be set for each channel individually, according to user’s preferences. Description in square brackets „[ ]” corresponds to the preset channel description.
- [3]: “No” means that the channel will not be included in sequential browsing in the "auto” mode. In the “auto” mode, you will be able to browse through the selected most important channels only. All channels are available in the manual browsing mode.
- [4]: The measurement results can be displayed as: large digits (**Large digits**), as a trend graph in time (**Trend graph**), as an analog line (**Bar graph**), along with totalisers (**Totalisers**), as a numerical result with the saved maximum, minimum and average value (**Min, max**) or as a line (**Min, max (bar)**). Each screen can be set to the **Hidden** mode. Only one screen can be set to a **Primary** status and shown as the first screen after switching to the applicable channel. When all channel screens are **Hidden**, the channel remains active but is not displayed. **Totalisers** screen is displayed in the menu only for channels with at least one active totaliser.
- [5]: Tables show tabulated measurement results from several channels. If large digits option is selected, a single table can include the results from up to three channels. If small digits option is selected, a single table can include the results from up to six channels.
- [6]: Selecting channels whose results are to be displayed in a specific table.

- [7]: When the results from subsequent channels are browsed manually, special screens will be displayed after the last channel: tables (**Table**), bar charts (**Bar chart**), alarm/control thresholds (**Thresholds**), relay outputs (**Relay outputs**), real-time clock (**Date and time**), and archive status screen (**Main archive**). Each screen can be **Hidden**. Hidden screens will not be displayed, but the screen functions will remain active.
- [8]: Selecting the background color. It can be black or white.
- [9]: LCD backlight can be still **ON** (continuously active) or can go out after a preset idle time (1 min - 10 min). The LCD will be backlit after any button is pressed.
- [10]: Backlight brightness can be set within the range of 50% - 100%, at 5% increments. Unlike all other functions, these settings are introduced instantly.
- [11]: Dimmed backlight brightness can be set within the range of 0% - 45%, at 5% increments when the LCD backlight is off. Use **TEST** to display the changed dimmed backlight brightness.

### 10.18. Device description



→ MAIN MENU → SETTINGS → DEVICE TAG

#### SETTINGS

Device tag = Process Data Recorder

### 10.19. Summer and winter time - automatic adjustment



→ MAIN MENU → SETTINGS → DST

#### SETTINGS

DST → Auto adjust (Auto adjust, Not used) <sup>[1]</sup>

Explanations:

- [1]: **DST** function, when **Auto adjust** is on, the device automatically adjusts a clock between summer time (DST - daylight saving time) and standard (winter) time. It is performed on the last Sunday of October at 3:00 and on the last Sunday of March at 2:00. This function should be switched off only if specifically required.

### 10.20. Saving to and loading settings from a file

Recording the device settings to an external USB data storage is available for all users. Loading settings is available for the administrator, for all users unless it was defined as protected activity (see Section 11.2), and for users with permissions to perform all activities protected.



→ MAIN MENU → LOAD OR SAVE SETTINGS

#### LOAD OR SAVE SETTINGS

Load <sup>[1]</sup>  
Save <sup>[2]</sup>



Explanations:

- [1]: The device settings can be loaded from a file stored in a flash drive connected to the USB port on the front panel of the instrument. This feature allows to restore previous settings, copy settings to another device or device configuration in case of periodically work in different measuring systems. Loading settings irretrievably override all settings, including passwords.
- [2]: Saving settings is possible only with the flash drive in USB port. Saving settings creates two files: *SETT\_[addr].set* and *SETT\_[addr].txt*. If in the memory flash drive files with the same name already exist, they will be overwritten. In order to keep in storage a few different settings files, after saving the settings, change the file name *SETT\_[addr].set* and *SETT\_[addr].txt* but keep the extension ".set" and ".txt". File *SETT\_[addr].txt* is a text file for informational purposes only. Loading settings are made only from a binary file with the extension ".set".

## 11. FUNCTIONS AVAILABLE ONLY FOR AN ADMINISTRATOR

Functions described in this section are reserved for the administrator only (ADMIN user, initial password: „1”).

### 11.1. Changing the Administrator Password

To change the administrator password, log in as an administrator and proceed as for user password changing.



→ MAIN MENU → CHANGE PASSWORD

The password is changed after a new numerical code is entered twice.

**!** If the administrator forgets its own password, it is necessary to contract the manufacturer and provide a numerical code. To generate the code, enter any password and select **NEW**. A new password will be assigned on the basis of this numerical code.

The administrator can also change the password of any user without the user's prior consent. This function is defined in detail in the section **Administrative data** → **Users and entitlements**.

### 11.2. Administrator menu

The administrator decides which functions of the instrument should be password protected. Creates new users, give them names, and generates a password (number codes). "ADMIN" also defines permissions for each user to perform password protected activities.

During the first configuration of the device, protected activity should be defined at first and then users accounts and permission assignment.



→ MAIN MENU → ADMINISTRATIVE DATA

#### ADMINISTRATIVE DATA

##### PROTECTED COMMANDS <sup>[1]</sup>

Archiving commands → **No** (Yes, No) <sup>[2]</sup>

Copy files → **No** (Yes, No) <sup>[3]</sup>

Resetting min, max → **No** (Yes, No) <sup>[4]</sup>

Adjusting clock → **No** (Yes, No) <sup>[5]</sup>

Resetting totalisers → **No** (Yes, No) <sup>[6]</sup>

Main settings → **No** (Yes, No) <sup>[7]</sup>

Threshold settings → **No** (Yes, No) <sup>[8]</sup>

Screen settings → **No** (Yes, No) <sup>[9]</sup>

Archiving settings → **No** (Yes, No) <sup>[10]</sup>



##### USERS AND ENTITLEMENTS <sup>[11]</sup>

LOG OUT AFTER → **5mins** (30secs, 1, 2, 3, 5, 10mins) <sup>[12]</sup>

MIN PASS LENGTH → **3digs.** (3, 4, 5) <sup>[13]</sup>



## Explanations:

- [1]: Actions are divided into groups. Each of them, may require entering a username and password. Thus, depending on the main application, it can be opt out completely of entering passwords (which always require additional operations on the keypad). It also allowed to select only specific operations that require passwords (e.g. changing the settings of the device), or to secure all possible actions (particularly when the recorded measurements are a document, and many people have access to the device). Selecting **Yes** means that the activities group will require a password.
- [2]: **Archiving commands** includes stopping (  ), and resuming (  ) recording and setting up a new archive file, if this action does not erase another archive located in the internal memory.
- [3]: **Copying files** include copy / move / delete operations of any file stored in the internal memory.
- [4]: **Resetting min, max** relates to the function of resetting maximum, minimum and average values stored and viewed on screens.
- [5]: Adjust clock refers to the entitlements to change the time and date clock (date and time is recorded in the archive along with the results of measurements).
- [6]: **Resetting the totalisers.**
- [7]: **Main settings** includes the addition of user's characteristics and functions of changing instrument's settings except for setting alarm and control thresholds, setting displaying screens and the settings of archiving.
- [8]: **Thresholds settings** - setting of alarm and control thresholds.
- [9]: **Screen settings** refers to setting of displaying of the results – main screens, additional screens and detailed screens.
- [10]: **Archiving settings** – setting frequency, process values and operating mode.
- [11]: In the **Users and entitlements** menu, the administrator defines users and gives them entitlements (selecting group of functions that the user will be able to perform after entering a password). After creating a new user device generates the numeric password. The instrument does not allow to change the password to a very simple one (e.g. 11111). Each user has a separately defined entitlements. ADMIN can choose only those activities that had previously been declared as a password protected activities. In this menu, the administrator can also change a user's name and password or remove user.
- [12]: **Log out after** – defines idle time after which the device automatically logs out. This function is to prevent accidentally leaving the device in logged mode, and to make changes by unauthorized persons.
- [13]: **Minimum password length** prevents users from changing password on too short. The longer the password is, the stronger it is, but more digits must be enter when logging on.

### 11.3. New firmware and licence granting

 The device firmware can be changed to a newer version or to the version with other features and possibilities. Substitution may be performed only by ADMIN user. This operation, if necessary, should be performed with extreme caution. The device can operate with a computer system or other devices and software change may affect it.



→ MAIN MENU → FIRMWARE AND LICENCES



## FIRMWARE AND LICENCES

- Load and install <sup>[1]</sup>
- Licences granted <sup>[2]</sup>
- Firmware version <sup>[3]</sup>
- Serial number <sup>[4]</sup>

Explanations:

- [1]: Installing new firmware or license granting is done via USB flash memory. After inserting the USB into the slot on the front panel of the device in main menu select **Load and install**. The device automatically detects files with the new firmware and license. Selecting the button **INSTALL** starts the process which takes a few minutes. Some versions of the program may not be compatible with the existing version, and in that case the instrument does not allow for the installation. Programs with special functions may require purchase of additional licenses.
- [2]: A list of **licenses granted** to instrument. Some programs can be installed only in instruments with a specific license. Use of certain features may require additional licenses.
- [3]: **Firmware version** - information about the version of firmware installed in the instrument.
- [4]: The device in the internal non-volatile memory has inscribed its **serial number**. The same number is located on the nameplate of the device. This is the service information. The serial number is also stored in each archives, in order to identify the measurement data to the device.

### 11.4. Restoring factory settings



→ MAIN MENU → RESTORE FACTORY SETTINGS

## MAIN MENU

### Restore factory settings <sup>[1]</sup>

Explanations:

- [1]: This function can change the settings entered by a user to the factory settings. It applies to all parameters grouped within the **Settings** menu, but does not change any other data stored in the device. The function should be used in special cases, for example, if user wants to set the device from the beginning, step by step.

### 11.5. Test of communication

Function **Communication test** is described in section 12.1.

### 11.6. Functions available only for service

User with the SERVICE permissions (ADMIN after entering the service code) has an additionally access to the calibration of the device, and remove / move of Event logs and Authorization log. Both of these features can be found at the end of the main menu.



**!** Unlike the other users, SERVICE user (ADMIN with a service code) does not log off automatically after a set period of inactivity. Administrator - SERVICE must remember to log out by himself.

## 12. TEST FUNCTIONS

### 12.1. Test of communication

**Communication test** function is available only for the ADMIN user, and requires to stop reading values from transmitters.

 → MAIN MENU → TEST KOMUNIKACJI

#### COMMUNICATION TEST

##### Modbus RTU <sup>[1]</sup>

**Baud rate** → **1200** (1200, 2400, 4800, 9600, 19200, 38400, 57600, 115200) <sup>[2]</sup>

**Parity** → **Even** (Even, Odd, None) <sup>[3]</sup>

**Address** = **1** ([value]) <sup>[4]</sup>

##### HART <sup>[5]</sup>

**Master** → **Primary** (Primary, Secondary) <sup>[6]</sup>

**Current address** = **0** ([value]) <sup>[7]</sup>

**New address** = **0** ([value]) <sup>[8]</sup>

- [1]: Test of communication in Modbus RTU protocol. Diagnostic command 08 is sent.
- [2]: Baud rate for communication with the transmitters or devices (only during the test)
- [3]: Parity setting (only during the test).
- [4]: Transmitter or device address to which is send diagnostic command. After entering this value 08 command is sent (Diagnostics).

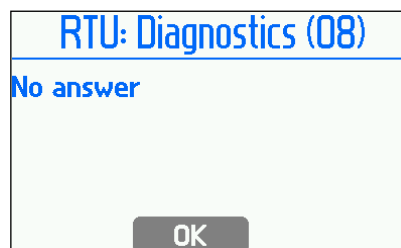
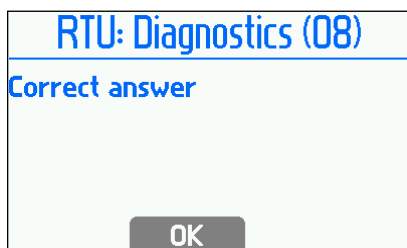

- [5]: Test of HART communication (command 0 is sent) and the ability to change the address of the transmitter.
- [6]: Selection of the device work mode.
- [7]: A short address of transmitter to which is sent command 0 (command is sent after entering this value).

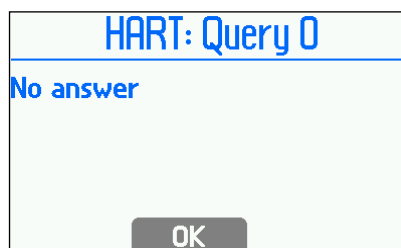
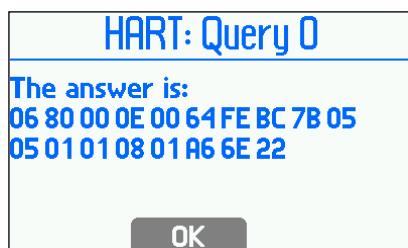

- [8]: After entering this value, **New address** will be sent to the transmitter with the address given in the **Current address**.

## 12.2. Port RS-485 (2) monitor

Function **RS-485 (2) monitor** is a service function. After selecting, the ALARM LED blinks when data exchange on the RS-485 bus. To end a function, press the button **QUIT**.

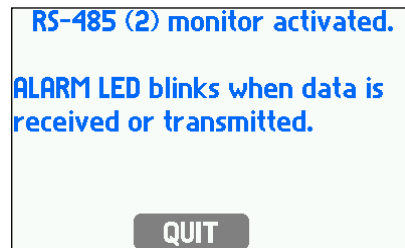

## 13. MPI-DN - WALL-MOUNTED VERSION

Wall-mounted version of the device has similar features as the version for panel-mounted. Supply voltage is 24 V DC/AC or 230 VAC.



*MPI-DN recorder face plate*

### 13.1. Housing

Housing allows wall-mounting and is made of ABS plastic.

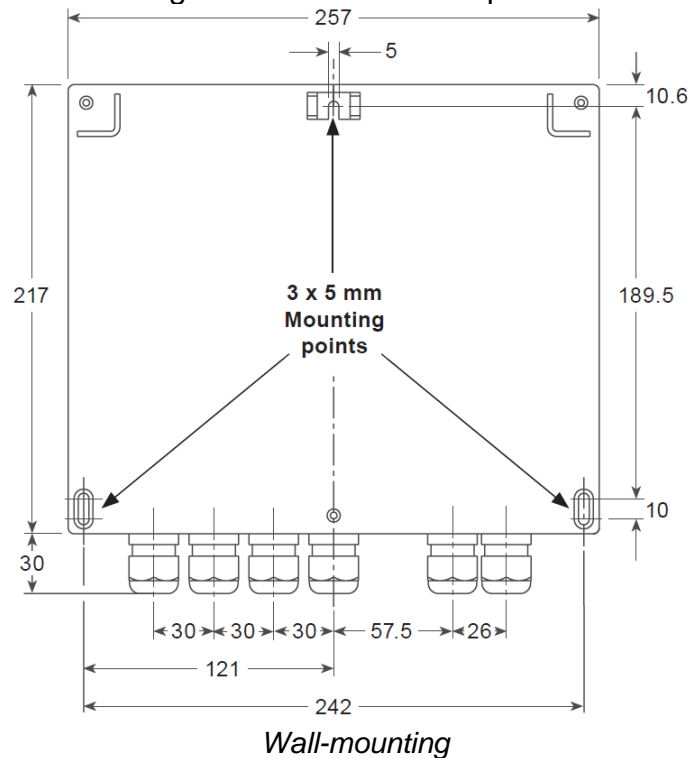

## 13.2. Connection of the electrical signals in the instrument MPI-DN

All electrical circuits are connected to a spring type terminal block.



*Pin type spring terminal block in MPI-DN recorder*

0.2 mm<sup>2</sup> - 0.5 mm<sup>2</sup> cables can be connected to the terminal block, and it is recommended to use cables with smaller diameters to save some space in the cable glands.

Terminal block no.	SPECIFICATION	
1	+24V	HART port
2	I+	
3	I-	
4	+	Serial port RS-485 (1)
5	T(+)	
6	A(+)	
7	B(-)	
8	T(-)	
9	G	PULS 1
10	F+	
11	F-	PULS 2
12	F+	
13	F-	Analog output 4-20mA (optional)
16	+24V	
17	I+	
18	I-	
19	+/~RL1	Relay output RL1 (0,1A/60V)
20	-/~ RL1	
21	+/~ RL2	Relay output RL2 (0,1A/60V)
22	-/~ RL2	
23	+/~ RL3	Relay output RL3 (0,1A/60V)
24	-/~ RL3	
25	+/~ RL4	Relay output RL4 (0,1A/60V)
26	-/~ RL4	



27	+	Serial port RS-485 (2)
28	T(+)	
29	A(+)	
30	B(-)	
31	T(-)	
32	G	
33	PE	Power supply 24VDC/AC
34	+/~ 24V	
35	-/~ 24V	
N	Power supply 230 VAC	
PE		
L		

*MPI-DN recorder terminal blocks*

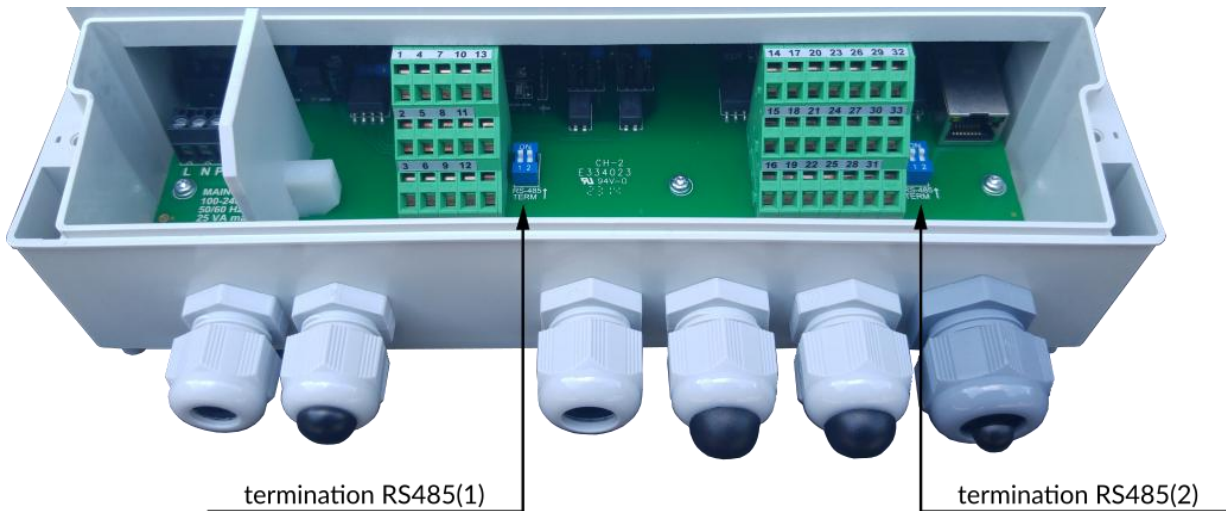

*DIP-switches for RS-485 bus termination*

### 13.3. Extended keyboard.

Extended keyboard version (7 + 12 keys) makes it easier to enter and edit numbers, text, formulas and passwords. Use the keyboard like a keyboard in your mobile phone, e.g. the button 2 has the following characters assigned: a, b, c, 2.



*Extended keyboard – button layout*

## 14. MPI-C-RAPORT RESULTS VISUALIZATION SOFTWARE

Measurement results in the electronic form are recorded in a format that is easy to view and process using available software. The 2GB capacity of the internal memory enables recording of large volumes of results. As a rule, there is no need to analyze all data in detail. It is therefore recommended to preselect data (from a specific time frame, lower or higher average / minimum / maximum values, in a chronological order, etc.) Use *MPI-C-Raport* (auxiliary equipment) to create a new, smaller file of source data. The selected data can be displayed either on graphs or in tables and printed report.

In order to ensure authenticity of original data, special techniques of encrypting data and keeping the order of records are used. Modification of original data is easy to perform (e.g. to calculate average values), however, it results in the encryption word being altered.

If recorded measurement results need to be stored, ensure proper procedures for storing original data to avoid loss or falsification. Data reading, backup creation and recording to recordable media (e.g. CDs) should be performed as frequently as possible. From time to time, user can also print reports.



## 15. Modbus RTU and Modbus TCP Protocol

Only few Modbus functions are implemented in MPI-D. Using Modbus functions user can transfer data to computer system:

- results of measuring process,
- archived data,
- date and time from RTC (Real Time Clock can also be set),
- alarms status.

There are four Modbus functions implemented:

- 02 – Read Discrete Inputs
- 04 – Read Input Registers
- 08 – Diagnostics
- 10 – Write Multiple Registers

Modbus RTU is available at RS-485 port and Modbus TCP is available at Ethernet port.

### 15.1. Serial port settings RS-485 for Modbus RTU

Default setting for port RS-485 is ASCII mode. It has to be set to Modbus RTU mode. Other parameters have to be set to correspond to computer or PLC settings:

- Address (01, .. , 99, addresses 100 to 247 are not implemented)
- Baud rate (2400, .. , 230,4k)
- Parity (NONE, ODD, EVEN)

Transmission parameters do not allow to set maximum time („Response delay (max):”) because response to a command is sent immediately in Modbus RTU mode. The maximum delay is no longer than few ms.

According to MODBUS standard in RTU mode the frame is as follows:

Start	Address	Function	Data	CRC control	End
T1 ... T4	1 byte	1 byte	n bytes	2 bytes	T1 ... T4

Information transmitted from the master computer to the device is a Query, whereas the device sends a Response.

### 15.2. Ethernet port settings for Modbus TCP

- IP (IP address assigned to MPI-D)
- Port (typically 502)
- Mask (subnet mask, e.g. 255.255.255.0)
- Gate (e.g. 1.0.0.1)
- DHCP server (OFF for normal operation)



- Timeout (typically 60 s)

Note: Using port 502 is recommended, since it is registered for Modbus TCP.

According to MODBUS standard in TCP/IP mode, the frame is as follows:

MBAP Header	Function	Data
7 bytes	1 byte	n bytes

Information transmitted from the master computer to the device is a Query, whereas the device sends a Response.

### 15.3. Readout of current results and totalisers

Readout function (query) has a form:

Function (1B)	Initial address (2B)	Number of registers (2B)
---------------	----------------------	--------------------------

Function – 04 HEX – current results readout.

Initial address – an address of a register from which data are to be sent.

Number of registers – two-byte registers to readout.

In response the device transmits a sequence of characters in form of:

Function (1B)	Number of bytes (1B)	Data sequence (nB)
---------------	----------------------	--------------------

Function – acknowledgement, in case of error 80 HEX value is added on to the command code.

Error codes possible for the device are:

- 01 HEX – incorrect function (in case of diagnostics also impermissible subfunction),
- 02 HEX – incorrect initial address,
- 03 HEX – incorrect number of points.

Queries are not confirmed by a response in case of:

- parity error,
- CRC errors,
- address error.

Number of bytes – n bytes transmitted in response (but not number of registers).

Data sequence – n bytes of register contents.

#### 15.3.1. Register addresses for current results

Current results in MPI-8v3 device are available in single floating point format, according to IEEE-754 standard for 32-bit numbers (4 bytes).



Registers` addresses (HEX)	Description
0080, 0081	Current value from input IN1
0082, 0083	Current value from input IN2
0084, 0085	Current value from input IN3
0086, 0087	Current value from input IN4
0088, 0089	Current value from input IN5
008A, 008B	Current value from input IN6
008C, 008D	Current value from input IN7
008E, 008F	Current value from input IN8
0090, 0091	Current value from input IN9
0092, 0093	Current value from input IN10
0094, 0095	Current value from input IN11
0096, 0097	Current value from input IN12
0098, 0099	Current value from input IN13
009A, 009B	Current value from input IN14
009C, 009D	Current value from input IN15
009E, 009F	Current value from input IN16
00A0, 00A1	Current value from input IN17
00A2, 00A3	Current value from input IN18
00A4, 00A5	Current value from input IN19
00A6, 00A7	Current value from input IN20
00A8, 00A9	Calculation value from input IN21
00AA, 00AB	Calculation value from input IN22
00AC, 00AD	Calculation value from input IN23
00AE, 00AF	Calculation value from input IN24
00B0, 00B1	Calculation value from input IN25
00B2, 00B3	Calculation value from input IN26
00B4, 00B5	Calculation value from input IN27
00B6, 00B7	Calculation value from input IN28
00B8, 00B9	Calculation value from input IN29
00BA, 00BB	Calculation value from input IN30
00BC, 00BD	Calculation value from input IN31
00BE, 00BF	Calculation value from input IN32
00C0, 00C1	Calculation value from input IN33
00C2, 00C3	Calculation value from input IN34
00C4, 00C5	Calculation value from input IN35
00C6, 00C7	Calculation value from input IN36

**IEEE-754 standard for 32-bit floating point numbers of single precision:**

Register	30002 (address 0001)				30001 (address 0000)	
Byte	4		3		2	1
Bit	31	30..24	23	22..16	15..08	07..00
IEEE-754	S	E (8b)		M (23b, only fraction part)		

where:



- M (mantissa): is a normalized value from the range [1;2)- right side open interval. Only fraction part of mantissa is noted (e.g. for binary number 1,1011101 mantissa equals to 1011101, more precisely in notation on 23 bits: 10111010000000000000000).
- E (exponent): exponent value is shifted by 127 (bias)
- S (sign): 0 – positive number, 1 – negative number.

The number value can be calculated from the formula:

$$x = (-1)^S * M * 2^{(E-bias)}$$

where bias: 127

For example, a sequence of response characters (HEX):

01 04 04 **9E E4 43 1C** A4 A2 (read from device)

- acknowledgment of an address (01) and function (04), number of bytes (04),
- value 9E E4 43 1C, in sequence register 0000 and 0001,
- CRC (A4 A2).

Presenting the value in appropriate sequence (0001 and 0000):

43 1C 9E E4

and in binary form:

01000011 00011100 10011110 11100100

one can read

- mantissa: 1,0011100 10011110 11100100 (in decimal notation: approx. 1,22265625)
- exponent: 10000110 – 01111111 = 00000111 (in decimal notation: 7)
- sign: 0

what gives a decimal result:

$$(-1)^0 * 1,22265625 * 2^7 = 156,5$$

### 15.3.2. Register addresses for totalisers

Totalisers in MPI-D device are available in two formats: in special integer format (4 bytes) and in double floating point format, according to IEEE-754 standard for 64-bit numbers (8 bytes).

NOTE!

Totalisers values in Modbus registers are updated every 2 sec.

Registers` addresses (HEX)	Description	Format
0400 ... 0403	Totaliser 1 for input IN1	floating point double
0404 ... 0407	Totaliser 2 for input IN1	floating point double



0408 ... 040B	Totaliser 1 for input IN2	floating point double
040C ... 040F	Totaliser 2 for input IN2	floating point double
0410 ... 0413	Totaliser 1 for input IN3	floating point double
0414 ... 0417	Totaliser 2 for input IN3	floating point double
0418 ... 041B	Totaliser 1 for input IN4	floating point double
041C ... 041F	Totaliser 2 for input IN4	floating point double
0420 ... 0423	Totaliser 1 for input IN5	floating point double
0424 ... 0427	Totaliser 2 for input IN5	floating point double
0428 ... 042B	Totaliser 1 for input IN6	floating point double
042C ... 042F	Totaliser 2 for input IN6	floating point double
0430 ... 0433	Totaliser 1 for input IN7	floating point double
0434 ... 0437	Totaliser 2 for input IN7	floating point double
0438 ... 043B	Totaliser 1 for input IN8	floating point double
043C ... 043F	Totaliser 2 for input IN8	floating point double
0440 ... 0443	Totaliser 1 for input IN9	floating point double
0444 ... 0447	Totaliser 2 for input IN9	floating point double
0448 ... 044B	Totaliser 1 for input IN10	floating point double
044C ... 044F	Totaliser 2 for input IN10	floating point double
0450 ... 0453	Totaliser 1 for input IN11	floating point double
0454 ... 0457	Totaliser 2 for input IN11	floating point double
0458 ... 045B	Totaliser 1 for input IN12	floating point double
045C ... 045F	Totaliser 2 for input IN12	floating point double
0460 ... 0463	Totaliser 1 for input IN13	floating point double
0464 ... 0467	Totaliser 2 for input IN13	floating point double
0468 ... 046B	Totaliser 1 for input IN14	floating point double
046C ... 046F	Totaliser 2 for input IN14	floating point double
0470 ... 0473	Totaliser 1 for input IN15	floating point double
0474 ... 0477	Totaliser 2 for input IN15	floating point double
0478 ... 047B	Totaliser 1 for input IN16	floating point double
047C ... 047F	Totaliser 2 for input IN16	floating point double
0480 ... 0483	Totaliser 1 for input IN17	floating point double
0484 ... 0487	Totaliser 2 for input IN17	floating point double
0488 ... 048B	Totaliser 1 for input IN18	floating point double
048C ... 048F	Totaliser 2 for input IN18	floating point double
0490 ... 0493	Totaliser 1 for input IN19	floating point double
0494 ... 0497	Totaliser 2 for input IN19	floating point double
0498 ... 049B	Totaliser 1 for input IN20	floating point double
049C ... 049F	Totaliser 2 for input IN20	floating point double
04A0 ... 04A3	Totaliser 1 for calculation result IN21	floating point double
04A4 ... 04A7	Totaliser 2 for calculation result IN21	floating point double
04A8 ... 04AB	Totaliser 1 for calculation result IN22	floating point double
04AC ... 04AF	Totaliser 2 for calculation result IN22	floating point double
04B0 ... 04B3	Totaliser 1 for calculation result IN23	floating point double
04B4 ... 04B7	Totaliser 2 for calculation result IN23	floating point double
04B8 ... 04BB	Totaliser 1 for calculation result IN24	floating point double
04BC ... 04BF	Totaliser 2 for calculation result IN24	floating point double
04C0 ... 04C3	Totaliser 1 for calculation result IN25	floating point double
04C4 ... 04C7	Totaliser 2 for calculation result IN25	floating point double



04C8 ... 04CB	Totaliser 1 for calculation result IN26	floating point double
04CC ... 04CF	Totaliser 2 for calculation result IN26	floating point double
04D0 ... 04D3	Totaliser 1 for calculation result IN27	floating point double
04D4 ... 04D7	Totaliser 2 for calculation result IN27	floating point double
04D8 ... 04DB	Totaliser 1 for calculation result IN28	floating point double
04DC ... 04DF	Totaliser 2 for calculation result IN28	floating point double
04E0 ... 04E3	Totaliser 1 for calculation result IN29	floating point double
04E4 ... 04E7	Totaliser 2 for calculation result IN29	floating point double
04E8 ... 04EB	Totaliser 1 for calculation result IN30	floating point double
04EC ... 04EF	Totaliser 2 for calculation result IN30	floating point double
04F0 ... 04F3	Totaliser 1 for calculation result IN31	floating point double
04F4 ... 04F7	Totaliser 2 for calculation result IN31	floating point double
04F8 ... 04FB	Totaliser 1 for calculation result IN32	floating point double
04FC ... 04FF	Totaliser 2 for calculation result IN32	floating point double
0500 ... 0503	Totaliser 1 for calculation result IN33	floating point double
0504 ... 0507	Totaliser 2 for calculation result IN33	floating point double
0508 ... 050B	Totaliser 1 for calculation result IN34	floating point double
050C ... 050F	Totaliser 2 for calculation result IN34	floating point double
0510 ... 0513	Totaliser 1 for calculation result IN35	floating point double
0514 ... 0517	Totaliser 2 for calculation result IN35	floating point double
0518 ... 051B	Totaliser 1 for calculation result IN36	floating point double
051C ... 051F	Totaliser 2 for calculation result IN36	floating point double

**IEEE-754 standard for 64-bit floating point numbers of double precision :**

Register address	e.g.: 0213 (hex)			e.g.: 0212 (hex)		e.g.: 0211 (hex)		e.g.: 0210 (hex)		
Byte	8		7		6	5	4	3	2	1
Bit	63	62..56	55..52	51..48	47..40	39..32	31..24	23..16	15..8	7..0
IEEE	S	E (11b)			M (52b, fraction part only)					

Where:

- M (mantissa): is a normalized value within the interval [1;2)- right side open interval. Only fraction part of mantissa is noted
- E (exponent): exponent value is biased by 1023 (bias).
- S (character): 0 – positive number, 1 – negative number

The number value can be calculated from the formula:

$$x = (-1)^S * M * 2^{(E-bias)}$$

where bias: 1023

The totaliser values are also available in double integer (4 byte) format. Only not rounded integer part of the totaliser value is available in this format in range from – 999 999 999 to 999 999 999.

Each totaliser value is 2 registers long (4 bytes).



Registers` addresses (HEX)	Description	Format
0600 ... 0601	Totaliser 1 for input IN1	integer
0602 ... 0603	Totaliser 2 for input IN1	integer
0604 ... 0605	Totaliser 1 for input IN2	integer
0606 ... 0607	Totaliser 2 for input IN2	integer
0608 ... 0609	Totaliser 1 for input IN3	integer
060A ... 060B	Totaliser 2 for input IN3	integer
060C ... 060D	Totaliser 1 for input IN4	integer
060E ... 060F	Totaliser 2 for input IN4	integer
0610 ... 0611	Totaliser 1 for input IN5	integer
0612 ... 0613	Totaliser 2 for input IN5	integer
0614 ... 0615	Totaliser 1 for input IN6	integer
0616 ... 0617	Totaliser 2 for input IN6	integer
0618 ... 0619	Totaliser 1 for input IN7	integer
061A ... 061B	Totaliser 2 for input IN7	integer
061C ... 061D	Totaliser 1 for input IN8	integer
061E ... 061F	Totaliser 2 for input IN8	integer
0620 ... 0621	Totaliser 1 for input IN9	integer
0622 ... 0623	Totaliser 2 for input IN9	integer
0624 ... 0625	Totaliser 1 for input IN10	integer
0626 ... 0627	Totaliser 2 for input IN10	integer
0628 ... 0629	Totaliser 1 for input IN11	integer
062A ... 062B	Totaliser 2 for input IN11	integer
062C ... 062D	Totaliser 1 for input IN12	integer
062E ... 062F	Totaliser 2 for input IN12	integer
0630 ... 0631	Totaliser 1 for input IN13	integer
0632 ... 0633	Totaliser 2 for input IN13	integer
0634 ... 0635	Totaliser 1 for input IN14	integer
0636 ... 0637	Totaliser 2 for input IN14	integer
0638 ... 0639	Totaliser 1 for input IN15	integer
063A ... 063B	Totaliser 2 for input IN15	integer
063C ... 063D	Totaliser 1 for input IN16	integer
063E ... 063F	Totaliser 2 for input IN16	integer
0640 ... 0641	Totaliser 1 for input IN17	integer
0642 ... 0643	Totaliser 2 for input IN17	integer
0644 ... 0645	Totaliser 1 for input IN18	integer
0646 ... 0647	Totaliser 2 for input IN18	integer
0648 ... 0649	Totaliser 1 for input IN19	integer
064A ... 064B	Totaliser 2 for input IN19	integer
064C ... 064D	Totaliser 1 for input IN20	integer
064E ... 064F	Totaliser 2 for input IN20	integer
0650 ... 0651	Totaliser 1 for calculation value IN21	integer
0652 ... 0653	Totaliser 2 for calculation value IN21	integer
0654 ... 0655	Totaliser 1 for calculation value IN22	integer
0656 ... 0657	Totaliser 2 for calculation value IN22	integer
0658 ... 0659	Totaliser 1 for calculation value IN23	integer





065A ... 065B	Totaliser 2 for calculation value IN23	integer
065C ... 065D	Totaliser 1 for calculation value IN24	integer
065E ... 065F	Totaliser 2 for calculation value IN24	integer
0660 ... 0661	Totaliser 1 for calculation value IN25	integer
0662 ... 0663	Totaliser 2 for calculation value IN25	integer
0664 ... 0665	Totaliser 1 for calculation value IN26	integer
0666 ... 0667	Totaliser 2 for calculation value IN26	integer
0668 ... 0669	Totaliser 1 for calculation value IN27	integer
066A ... 066B	Totaliser 2 for calculation value IN27	integer
066C ... 066D	Totaliser 1 for calculation value IN28	integer
066E ... 066F	Totaliser 2 for calculation value IN28	integer
0670 ... 0671	Totaliser 1 for calculation value IN29	integer
0672 ... 0673	Totaliser 2 for calculation value IN29	integer
0674 ... 0675	Totaliser 1 for calculation value IN30	integer
0676 ... 0677	Totaliser 2 for calculation value IN30	integer
0678 ... 0679	Totaliser 1 for calculation value IN31	integer
067A ... 067B	Totaliser 2 for calculation value IN31	integer
067C ... 067D	Totaliser 1 for calculation value IN32	integer
067E ... 067F	Totaliser 2 for calculation value IN32	integer
0680 ... 0681	Totaliser 1 for calculation value IN33	integer
0682 ... 0683	Totaliser 2 for calculation value IN33	integer
0684 ... 0685	Totaliser 1 for calculation value IN34	integer
0686 ... 0687	Totaliser 2 for calculation value IN34	integer
0688 ... 0689	Totaliser 1 for calculation value IN35	integer
068A ... 068B	Totaliser 2 for calculation value IN35	integer
068C ... 068D	Totaliser 1 for calculation value IN36	integer
068E ... 068F	Totaliser 2 for calculation value IN36	integer

**15.4. Readout alarm threshold exceedances – function 02**

In case of readout of alarm threshold exceedances (function 02 HEX), a sequence bit values will be transmitted. Alarmed state for each threshold is coded on two bits.

Readout function (query) has a form:

Function (1B)	Initial address (2B)	Number of points (2B)
------------------	-------------------------	--------------------------

Function – 02 HEX – reading out alarm threshold exceedances.  
 Initial address – a number of bit from which data are to be sent.  
 Number of points – number of bits.

In response the device transmits a sequence of characters in form of:

Function (1B)	Number of bytes (1B)	Data sequence (nB)
------------------	-------------------------	-----------------------





Function – acknowledgement, in case of error 80 HEX value is added on to the command code.

Error codes possible for the device are:

- 01 HEX – incorrect function (in case of diagnostics also impermissible subfunction),
- 02 HEX – incorrect initial address,
- 03 HEX – incorrect number of points.

Queries are not confirmed by a response in case of:

- parity error,
- CRC errors,
- address error.

Number of bytes – n bytes transmitted in response (8 bites = 1 byte, if query declares number of bits indivisible by 8, the last bits are completed by value 0 to number divisible by 8).

Data sequence – n bytes of registers' contents.

### 15.4.1. Numbers of bits for reading out alarm threshold exceedances

Number of bit (HEX)	Meaning
0000 ... 0007	Reserve
0008	Channel 1 threshold 4 H
0009	Channel 1 threshold 4 L
000A	Channel 1 threshold 3 H
000B	Channel 1 threshold 3 L
000C	Channel 1 threshold 2 H
000D	Channel 1 threshold 2 L
000E	Channel 1 threshold 1 H
000F	Channel 1 threshold 1 L
0010 ... 0017	Reserve
0018	Channel 2 threshold 4 H
0019	Channel 2 threshold 4 L
001A	Channel 2 threshold 3 H
001B	Channel 2 threshold 3 L
001C	Channel 2 threshold 2 H
001D	Channel 2 threshold 2 L
001E	Channel 2 threshold 1 H
001F	Channel 2 threshold 1 L
...	...
0230 ... 0237	Reserve
0238	Channel 36 threshold 4 H
0239	Channel 36 threshold 4 L
023A	Channel 36 threshold 3 H
023B	Channel 36 threshold 3 L
023C	Channel 36 threshold 2 H
023D	Channel 36 threshold 2 L
023E	Channel 36 threshold 1 H
023F	Channel 36 threshold 1 L



H	L	Description
0	0	No exceedance.
0	1	Exceedance notified unconfirmed (only for alarm exceedance).
1	1	Exceedance notified confirmed (for alarm exceedance).
1	1	Exceedance (for control exceedance).

## 15.5. Reading out archives

Two function are used to readout archives: 04 (Read Input Registers) and 10 (Write Multiple Registers).

The modification of values, required to readout archives, is possible by function 10 (Write Multiple Registers):

- step (see registers' addresses for archive of current value – register 0200),
- time (see registers' addresses for archive of current value – registers 0201, 0202 and 0203),
- number (see registers addresses for archive of current value – registers 0204 and 0205).

In addition, function allows clock's settings to be modified (see section "Readout and settings of clock").

Record function (query) has a form:

Function (1B)	Initial address (2B)	Number of registers = N (2B)	Number of data bytes (1B)	Data to record (N x 2B)
------------------	----------------------------	------------------------------------	---------------------------------	-------------------------------

Function – 10 HEX – record to one or several registers.

Initial address – an address of first register .

Number of registers – two-byte registers for record.

Number of data bytes – number of bytes which will be recorded.

Data to record – data bytes which will be record to specified registers.

In response the device transmits a sequence of characters in form of:

Function (1B)	Initial address (2B)	Number of registers (2B)
------------------	-------------------------	-----------------------------

Function – acknowledgement, in case of error 80 HEX value is added on to the command code.

Error codes possible for the device are:

- 01 HEX – incorrect function (in case of diagnostics also impermissible subfunction),
- 02 HEX – incorrect initial address,
- 03 HEX – incorrect number of points.

Queries are not confirmed by a response in case of:

- parity error,
- CRC errors,
- address error.

Initial address – an address of first register contenting recorded data.



Number of registers – number of registers containing recorded data.

**NOTE!!!**

It's possible to record just one field(step, number or time) in single 10 query.

Queries containing more than one field or any field partially (ex. only 0116 register), will be rejected with error code 02.

Algorithm to readout archive of current results:

- To readout an archive of current results is useful 04 function.
- Registers 0100...0116 contain general information,
- Registers 0206...02FF contain one record or one headline.
- Every readout query containing registers 0204 or 0205 causes move on to consecutive record (number of record is increased by value of register 0200, default 1, can be substituted by input of new value using 10 function) or to consecutive headline.
- After readout of registers 0204 and 0205, new record or next headline will be available at registers 0206...02FF,
- Readout of last headline or last record causes move on to first record.
- To move on to selected headline, record selected number to registers 0204 and 0205 is required,
- To move on to selected record, it's required to record selected number or time of record to proper register (0204, 0205 – number of record, 0201...0203 – time of record) using an 10 function.

### 15.5.1. Registers' addresses for readout of archive of current results

Registers` addresses (in DEC format)	Format	Description
<b>General information</b>		
0100, 0101	Ulong	Number of available records
0102, 0103	Ulong	Number of saved records
0104, 0105	Ulong	Fill, number of records saved since indicator of memory space usage was reset.
0106, 0107	Ulong	Last saved record, consecutive number of last saved record.
0108, 0109, 010A	Time	Time of highest record
010B, 010C, 010D	Time	Time of lowest record
010E, 010F, 0110	Time	Time of memory space usage indicator reset
0111, 0112, 0113	Time	Expected time of end of memory space. Values of 0x00 denote that archive is fulfilled. Values of 0xFF denote that expected time won't be in 21st century
0114	Uint	Status
0115	Uint	Size of record in bytes (without end of line characters)
0116	Uint	Size of headline
<b>Record or headline</b>		
0200	Uint	Step, number of records to move on after every readout. Don't concern headline readout.



<b>0201, 0202, 0203</b>	Time	Time of record save. If there's no record in registers 0206...02FF, then value in this field is random.
<b>0204, 0205</b>	Ulong	Points which record or which headline's is currently available in registers 0206...02FF: 0xFFFFFFFF – no data in registers 0206...02FF,  0...0x7FFFFFFF – consecutive records,  Up from 0x80000000 – number of headline <b>NOTE! For example, line 3 is 0x80000002</b>
<b>0206</b>	2 x char	Record or headline in string form ended by null digit . There are two ASCII chars in each register (first one is on the highest bytes). Late, unused registers are filled by zero digits. String doesn't contain end of line characters.
...	...	
<b>02FF</b>	2 x char	

### Table formats:

Uint – unsigned integer saved in one register (2bytes),

Ulong – unsigned integer saved in two registers (4 bytes), in first register are saved lowest 16 bites of them,

Time, consecutive:

- Year (High byte of first register),
- Month (Low byte of first register),
- Day (High byte of second register),
- Hour(Low byte of second register),
- Minutes (High byte of third register),
- Seconds (Low byte of third register).

Char – one char on one byte.

**NOTE!!! For instance, for 4 byte number ABCD:**

**CD – low 16 bits (low byte),**

**AB – high 16 bits (high byte).**

### 15.5.2. Registers' addresses to which recording is possible.

Registers' addresses (in HEX format)	Format	Description
<b>0200</b>	Uint	Step, number of records to move on after every readout. Don't concern headline readout.
<b>0201, 0202, 0203</b>	Time	Time of record save. If there's no record in registers 0206...02FF, then value in this field is random
<b>0204, 0205</b>	Ulong	Points which record or which headline is currently shared in registers 518...767:  0xFFFFFFFF – no data in registers 0206...02FF,  0...0x7FFFFFFF – consecutive records ,



		Up from 0x80000000 – number of headline <b>NOTE! For example, line 3 is 0x80000002</b>
--	--	---

Time, consecutive:

- Year (High byte of first register),
- Month (Low byte of first register),
- Day (High byte of second register),
- Hour (Low byte of second register),
- Minutes (High byte of third register),
- Seconds (Low byte of third register).

Char – one char on one byte.

**NOTE!!! For instance, for 4 byte number ABCD:**  
**CD – low 16 bits (low byte),**  
**AB – high 16 bits (high byte).**

## 15.6. Readout and settings of clock

Current time is read by 04 command.

To modify clock's settings user should use 10 command. This command have to contain strictly all three registers. In another time will be rejected with error code 02.

### 15.6.1. Registers' addresses of clock

Registers' addresses (in DEC format)	Format	Description	
		High byte	Low byte
0020	Time	Year	Month
0021	Time	Day	Hour
0022	Time	Minute	Second

**NOTE!!!**

**For instance, for 2 byte number AB:**  
**B – low 8 bits (low byte),**  
**A – high 8 bits (high byte).**

Year, month, Day, hour, minute, second should be entered in HEX system. In the following table is an example for date 2009-12-25 and time 15:40:00:

Registers' addresses (HEX)	Number
0020	090C
0021	190F
0022	2800



## 15.7. Function 08 (Diagnostics)

The MPI-D device accepts only one diagnostics command – return of received control data (“echo”).

Diagnostics function (query) has a form:

Function (1B)	Subfunction (2B)	Data (2B)
------------------	---------------------	--------------

Function – 08 HEX – diagnostics.

Subfunction – only 0000 HEX – return of received data.

Data – two bytes of data in any value.

In response, the device transmits a sequence of characters in form of:

Function (1B)	Subfunction (2B)	Data (2B)
------------------	---------------------	--------------

Function – acknowledgement, in case of error 80 HEX value is added on to the command code.

Error codes possible for the device are:

- 01 HEX – incorrect function (in case of diagnostics also impermissible subfunction),
- 02 HEX – incorrect initial address,
- 03 HEX – incorrect number of points.

Queries are not confirmed by a response in case of:

- parity error,
- CRC errors,
- address error.

Subfunction – acknowledgement.

Data – return of two received bytes of data.