

# DL2

## MULTICHANNEL ELECTRONIC DATA LOGGER

### OPERATING MANUAL

Version: 250219 EN

Device version: 2.0

**metronic**

**Before installation, carefully read all the instructions, especially those concerned with Environment, Health and Safety (EHS).**

**The recorder has been manufactured according to the requirements of relevant EU directives.**

**These instructions must be stored in a safe place near the installation of the device at all times.**

### **Information from the Manufacturer**

**All functions of the recorder are subject of modifications for the benefit of technical progress.**

**MODBUS®** is a registered trademark of Modbus Organization, Inc., North Grafton, MA 01536 USA

**TABLE OF CONTENTS**

<b>1</b>	<b>SAFETY INFORMATION AND INSTRUCTIONS .....</b>	<b>7</b>
<b>2</b>	<b>DL2 DELIVERY CONTENT, ACCESSORIES AND STORAGE .....</b>	<b>10</b>
2.1	Basic components .....	10
2.2	Storage.....	10
2.3	Accessories (optional).....	10
<b>3</b>	<b>GENERAL PRODUCT OVERVIEW .....</b>	<b>11</b>
3.1	Purpose.....	11
3.2	Basic functions .....	11
3.3	Software for PC.....	13
3.4	Available options .....	13
3.5	Device configuration information .....	14
3.6	Galvanic separation in the device .....	15
<b>4</b>	<b>DL2 AVAILABLE I/O MODULES .....</b>	<b>16</b>
4.1	DL2 base set.....	16
4.2	IN6I(24V) – six channel 0-20mA or 4-20mA input type module.....	16
4.3	IN6I – six channel 0-20mA or 4-20mA input type module .....	16
4.4	IN6T - six-channel temperature module .....	16
4.5	IN6V – six channel voltage type input module.....	17
4.1	IN6 - six-channel universal analog input module .....	17
4.2	IN4SG – four channel strain gauge input module.....	17
4.3	IN3D – three-channel binary input module .....	17
4.4	IN6D – six channel binary inputs module .....	18
4.5	2RS485(24V) – two RS485 port input module (Modbus RTU Master) .....	18
4.6	2RS485 – two RS485 port input module (Modbus RTU Master).....	18
4.7	1HRT – HART (4-20 mA) port input module.....	18
4.8	OUT6RL – six channel relay outputs module .....	19
4.9	OUT3 – three channel analogue outputs module .....	19
4.10	PSBATT – module for operation with a back-up battery .....	19
<b>5</b>	<b>MECHANICAL INSTALLATION.....</b>	<b>20</b>
<b>6</b>	<b>ELECTRICAL INSTALLATION .....</b>	<b>22</b>
6.1	Power supply connection (Module M) .....	22
6.2	I/O modules – wiring diagrams (SLOT A and B) .....	23
6.2.1	IN6I(24V) – six channel 0-20mA or 4-20mA input type module .....	23
6.2.2	IN6I – six channel 0-20mA or 4-20mA input type module.....	24
6.2.3	IN6T - six-channel temperature module.....	25

---

6.2.4	IN6V – six channel voltage type input module .....	26
6.2.5	IN6 - six-channel universal analog input module .....	27
6.2.6	IN4SG – four channel strain gauge inputs module .....	28
6.2.7	IN3D – three-channel binary input module .....	29
6.2.8	IN6D – six channel binary inputs module.....	30
6.2.9	2RS485(24V) – two RS485 port input module (Modbus RTU Master).....	31
6.2.10	2RS485 – two RS485 port input module (Modbus RTU Master) .....	32
6.2.11	1HRT – HART (4-20 mA) port input module.....	33
6.2.12	OUT6RL – six channel relay outputs module .....	34
6.2.13	OUT3 – three channel analogue outputs module .....	34
6.2.14	PSBATT – back-up battery module .....	36
6.3	Wiring diagrams for module M .....	38
6.3.1	Wiring diagram for the analog output.....	38
6.3.2	Wiring diagram for the relay outputs .....	38
6.3.3	Connection of RS-485 data transmission line.....	38
6.3.4	Ethernet port.....	39
<b>7</b>	<b>FRONT PANEL AND MAIN FUNCTION BUTTONS .....</b>	<b>40</b>
7.1	Front panel.....	40
7.1.1	Title bar.....	41
7.1.2	Menu bar .....	41
<b>8</b>	<b>FIRST START UP AND KEY ACTIVITIES .....</b>	<b>42</b>
8.1	Access control, login and change of user password .....	42
8.1.1	Access control .....	42
8.1.2	Login.....	42
8.1.3	Changing the password .....	43
8.2	Change of the language .....	43
8.3	Recommended order for configuration of the device.....	43
8.4	Reading and saving files using the USB port .....	45
8.5	Factory settings.....	46
<b>9</b>	<b>TECHNICAL SPECIFICATIONS.....</b>	<b>47</b>
<b>10</b>	<b>ENTITY LAUNCHING THE PRODUCT ON EUROPEAN UNION MARKET .....</b>	<b>56</b>
<b>11</b>	<b>USER SCREENS .....</b>	<b>57</b>
11.1	Information about the device .....	57
11.2	Results Tables .....	58
11.3	Trends.....	58
11.4	Single result window .....	59

---

11.5	Archive .....	60
11.6	Main Menu .....	61
11.7	Alarms .....	62
<b>12</b>	<b>PROGRAMMING SETTINGS .....</b>	<b>63</b>
12.1	General settings .....	63
12.1.1	General .....	63
12.1.2	Display .....	64
12.1.3	Date & Time .....	64
12.1.4	Service .....	65
12.2	Input and output settings .....	65
12.2.1	Module M (MAIN) .....	66
12.2.2	Programming options for the individual modules .....	66
12.3	Communication settings .....	72
12.3.1	Ethernet port .....	72
12.3.2	E-mail .....	73
12.3.3	Modbus TCP (Client) .....	74
12.3.4	RS-485 port .....	76
12.4	Channels settings .....	76
12.4.1	Inputs .....	76
12.4.2	General .....	78
12.4.3	Alarm .....	79
12.4.4	Totalizers .....	79
12.5	Screen settings .....	80
12.5.1	Results Tables .....	81
12.5.2	Trends .....	81
12.6	Archive settings .....	82
<b>13</b>	<b>ARCHIVE .....</b>	<b>83</b>
13.1	Start, resume and stop archiving .....	83
13.2	Archive settings .....	83
13.3	Archive files types .....	83
13.4	Way of creating an archive file .....	83
13.5	Time interval of archiving data .....	83
13.6	Archive files organization .....	84
13.6.1	Data archive .....	84
13.6.2	Totalizer archive .....	85
13.6.3	Event archive .....	85

---

13.7	Copying archive files from the device.....	86
13.7.1	Copying archive files to USB flash memory .....	86
13.7.2	Copying archive files using device web server .....	86
13.8	Automatic disk cleaning system .....	86
<b>14</b>	<b>ADDITIONAL FUNCTIONS .....</b>	<b>88</b>
14.1	Additional channel functions.....	88
14.1.1	Math channels.....	88
14.1.2	User characteristics.....	89
14.1.3	Copying channel settings .....	90
14.2	Print screen.....	90
14.3	Web server.....	91
14.4	Software for PC.....	93
14.4.1	DL-Config.....	93
14.4.2	M-Raport .....	94
<b>15</b>	<b>FAILURE SYMBOLS.....</b>	<b>95</b>
15.1	Failure symbols for 1HRT module.....	95
<b>16</b>	<b>MODBUS RTU / MODBUS TCP TRANSMISSION PROTOCOL .....</b>	<b>96</b>
16.1	General information.....	96
16.1.1	Data types.....	96
16.2	Registers addresses .....	96
16.2.1	Addresses table of Process values .....	96
16.2.2	Addresses table of Totalizer 1 .....	97
16.2.3	Addresses table of Totalizer 2.....	97
16.2.4	Alarm status addresses and alarm acknowledgements .....	97

## 1 SAFETY INFORMATION AND INSTRUCTIONS

Safe operation of this product can only be guaranteed if it is properly installed, commissioned, used and maintained by qualified personnel in compliance with the operating instructions. General installation and safety instructions for pipeline and plant construction, as well as the proper use of tools and safety equipment must also be complied with.

### Symbols

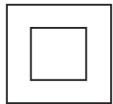

Equipment is protected throughout by double insulation or reinforced insulation.



Functional earth (ground) terminal, to enable the product to function correctly. Not used to provide electrical safety.



Caution, risk of electric shock.



Caution, risk of danger, refer to accompanying documentation.



Caution, Electrostatic Discharge for sensitive circuit. Do not touch or handle without proper electrostatic discharge precautions.



Important comments and information.

### Warning

This product is designed and manufactured to withstand the forces encountered during normal use. Use of the product contrary to its intended purpose or incorrect installation of it, any type of modifications or repairs incompatible with the following instructions could:

- cause damage to the product/property,
- cause injury or fatality to personnel,
- void the warranty of product,
- invalidate the **CE** marking.



**Always isolate the mains supply before opening the product as hazardous voltages may be exposed.**

**Warning**

This product complies with the requirements of the following directives and harmonized standards:

EMC Directive 2014/30/EU to the following standards and specifications:

- For EMC immunity for industrial environments according to EN 61326-1:2013 Table 2.
- For EMC conductive and radiated emissions according to EN 61326-1:2013 Class A equipment.

The product may be exposed to interference above the limits of EN 61326 if:

- The product or its wiring is located near a radio transmitter.
- Excessive electrical noise occurs on the mains supply. Power line protectors (AC) should be installed if mains supply noise is likely to happen. Protectors can combine filtering, suppression, surge and spike arresters.
- Cellular telephones and mobile radios may cause interference if used within approximately 1 metre (39") of the product or its wiring. The actual separation distance necessary will vary according to the surroundings of the installation and the power of the transmitter.

**Warning**

This device is an Class A type instrument. In operational environment, it may cause radio interference. In such cases, one can request to the users for appropriate measures to avoid it.

**Intended use**

- Check that the product is suitable for use with the application.
- Determine the correct installation and physical situation.
- Prior to installation of Metronic AKP products, take into account any environmental limitations of devices, specified in the manual.

**Access**

Ensure safe access and if necessary a safe working platform (suitably guarded) before attempting to work on the product.

**Lighting**

Ensure that there is adequate lighting, particularly where detailed or complicated work is required.

**Hazardous environment around the product**

Consider: explosion risk areas, lack of oxygen (e.g. tanks or pits), dangerous or harmful gases, extremes of temperature, hot surfaces, fire hazard (e.g. during welding), excessive noise, moving machinery.

**The system**

Consider the effect on the complete system of the work proposed. Will any proposed action put any other part of the specific system or any personnel at risk?

Dangers might include isolation of vents or protective devices or the rendering ineffective of controls or alarms.





### **Tools and consumables**

Before starting work ensure that you have suitably required tools and/or consumables available at the work place.

### **Protective clothing**

Consider whether you and/or others in the vicinity require any protective clothing to protect against the hazards of, for example, chemicals, high/low temperature, radiation, noise, falling objects, and dangers to eyes and face.

### **Permits to work**

All the work must be carried out or be supervised by a suitably competent person. Installation and operating personnel should be trained in the correct use of the product according to the Installation and Maintenance Instructions. Where a formal 'permit to work' system is in force it must be complied with. Where there is no such system, it is recommended that a responsible person should know what work is going on and, where it is necessary, arrange to have an assistant whose primary responsibility is safety.

Post 'warning notices' if it is necessarily required.

### **Cleaning and maintenance**

Metronic AKP products require no maintenance beyond periodic battery replacement. Expected battery life is 10 years after the expiry of which must be returned to the manufacturer for a replacement.

From time to time you should clean the casing with a dry, soft cloth. When cleaning, do not use solvents or abrasives. They may cause discoloration or scratch the surfaces of device.

### **Disposal**

The DL2 contains a battery. On disposal of the unit or component, appropriate precautions shall be taken in accordance with Local/National regulations.

Unless otherwise stated in the Installation and Maintenance Instructions, with the exception of the battery, this product is recyclable and no ecological hazard is anticipated with its disposal providing due care is taken.

### **Returning products**

Customers are reminded that under EHS regulations, when returning products to Metronic AKP they must provide information on any hazards and the precautions to be taken due to contamination residues or mechanical damage which may present an Environment, Health and Safety (EHS) risk. This information must be provided in writing including Health and Safety data sheets relating to any substances identified as hazardous or potentially hazardous.

---

## **2 DL2 DELIVERY CONTENT, ACCESSORIES AND STORAGE**

**Prior to dispatch, each Metronic AKP device is inspected and calibrated to ensure proper and efficient operation.**

### **CAUTION**

Upon receipt, each package should be inspected for any potential damage.

The content of the whole package should also be checked and the actual number of elements should be compared against the manufacturer's list of items presented in the consecutive subsection. In the case of damage or lack of elements, a report should be drawn up in the presence of the carrier specifying the date of receipt and signature of the person delivering the package.

### **2.1 Basic components**

- The DL2 Data Logger configured to individual customer's order 1 pc.
- A set of plug-in type screw connection 1 set
- Fixing clamp 2 pc.
- Seal (assembled between case and panel) 1 pc.
- Warranty Card 1 pc.
- Certificate of Calibration 1 pc.

### **2.2 Storage**

If the device is to be stored if not used for a period of time and prior to the assembly, the required storage conditions should be observed prior to assembly. The device should be kept in ambient temperature range from -30 °C to 70 °C at the relative humidity at 5% to 95% (non-condensing).

Prior the installation and connecting the device to the power supply make sure that there is no condensate water inside the device.

### **2.3 Accessories (optional)**

- CONV485E
- CONV485USB-I
- CONV485USB
- Power supply unit
- USB flash drive

### 3 GENERAL PRODUCT OVERVIEW

#### 3.1 Purpose

DL2 is a multi-channel microprocessor-based measuring device with electronically recorded measurement results. The device is intended to measure process signals in industrial applications and may be used to measure physical values processed into a standard current loop signal 0-20mA or 4-20mA, e.g. temperature, humidity, pressure, flow, level and chemical composition, etc. The device is perfectly suited for slow rate variable runs with changes at a few seconds intervals. Process values recording and flexible I/O configuration, makes the DL2 data logger suitable for monitoring parameters in warehouse settings or in the supervision of production lines. The device has math channels that enable selected mathematical operations on the measured values, according to the formulas entered by the user. The user configurable display and browse functions makes the device suitable for use as a paper-less electronic logger. The device may be connected to a PC or plant control system via Ethernet or RS-485 communication ports.

Each device is provided with a basic module and can be extended with additional I/O modules. Details are provided in section [DL2 AVAILABLE I/O MODULES](#).

The device is supplied with 24 VDC source. Detailed information concerning the power supply is given in consecutive parts of the document, in section [Power connection](#).

#### 3.2 Basic functions

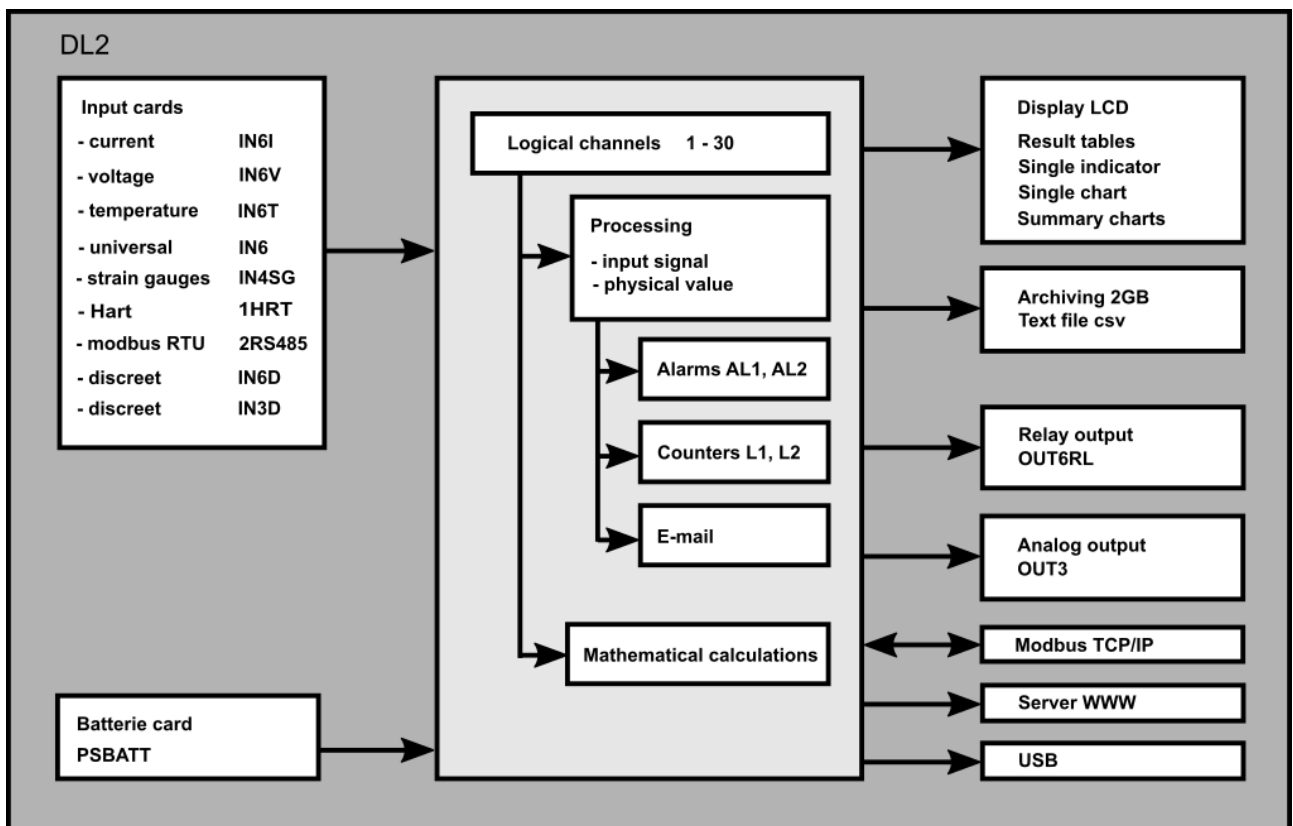

- **30 programmable channels**

The device enables setting up to 30 freely programmable channels. For each of them the current, the maximum and the minimum value of the channel is displayed.

- **Measurement of the process values**

Depending on the needs, the device may be provided with up to 12 measurement inputs/outputs. The read values can be assigned to channels and archived.

- **Remote reading transmitter in the HART protocol**

If two 1HRT modules are installed, then the device enables remote reading of up to 30 values in the HART protocol. For one module, up to 25 values can be read. It is possible to read the variables PV, TV, SV, FV and DVC. The read values can be assigned to channels and archived.

- **Remote reading transmitter with digital output – Modbus RTU**

If two 2RS485(24V) or 2RS485 modules are installed, then the device enables remote reading of up to 30 values (Modbus RTU protocol). For one module, up to 25 values can be read. The read values can be assigned to channels and archived.

- **Remote reading transmitter with digital output – Modbus TCP (Client)**

The device enables remote reading of up to 30 values from 20 devices (Modbus TCP protocol). The read values can be assigned to channels and archived.

- **Flow measurement**

Each measurement input (including binary inputs) and each calculated value have two independent totalizers assigned. Totalizers for pulse inputs can provide precise pulses count. Message containing totalizers values can be sent automatically in the form of an e-mail (up to 5 recipients) at the indicated hour every day, on a selected day of the week or on a selected day of the month.

- **Alarms and control**

Two alarm thresholds may be set for every channel. Binary outputs can be assigned to alarm thresholds. Two modes are available for alarms: latched ('Alarm' mode) and non-latched ('Control' mode). 4 alarm relays are available as a standard. Next 12 relays may be installed as an I/O modules. The message about exceeding the alarm threshold and return to the normal value can be sent automatically in the form of an e-mail (up to 5 recipients).

- **Analog output**

One 4-20 mA output is available as a standard. Next 6 outputs may be installed as an I/O modules.

- **Math channels**

Within the math channels, selected mathematical operations are available: addition, subtraction, division, multiplication, raising to the 2, 3 or any power and square root. The formula entered in the math channel can contain up to 200 characters.

- **Results recording**

Process values, math channels and totalizers can be recorded into internal flash memory with the capacity of 2 GB. Data are saved as text files and protected with encoded checksum. Apart from the measured values, the recorder also saves events (power loss, resetting, exceeded threshold values, etc.) and authorised operations.

- **Displaying the results**

Measured and calculated results can be displayed on the 4" colour LCD screen. Depending on the configuration, results are displayed as graphs or digits (max. 11 signs displayed for process values and max. 14 signs displayed for totalizers; after exceeding the measuring range for process value or totalizer value, the ----- symbol will be displayed on the screen and will be saved in the archive). The results can be also displayed collectively as trend charts or tables (max. 11 signs for process values and totalizers values). Measurement screens can be browsed sequentially or set to a selected channel.

- **Communication with a supervisory computer or a control system**

The recorder enable data transmission to a supervisory computer or a control system by means of:

- a built-in RS-485 serial port; available Modbus RTU protocol,
- Ethernet port; available Modbus TCP protocol.

### 3.3 Software for PC

Additional dedicated software can be downloaded from the Manufacturer's website: [www.metronic.pl](http://www.metronic.pl).

- **Software for device configuration**

DL2 - dedicated software (*DL-Config.exe*) enables device configuration through the use of the computer. The software is intuitive and has an interface which is very similar to the interface of the device. The software can be installed on the computers with the MS Win operating system. Additional information in section [DL-Config](#).

- **Software for archive data visualization and analysis**

The REPORT software (*M-Raport.exe*) for archived data enables visualization and analysis, using the computer. The *M-Raport.exe* program enables online transfer of archived data. Additional information in section [M-Raport](#).

### 3.4 Available options

DL2 is a data recorder created with a view to enabling the best possible adaptation of the device to the individual needs of the customer. Each device is composed of the base module to which depending on the metrological needs additional, carefully selected, input and output modules can be attached. Depending on the needs, the device may have installed up to two additional modules. Each of them is optionally provided with 3 or 6 measurement channels.

The device is available in DL2 panel mount and wall mount versions with DL2W KIT.

	Faceplate	Side view
<b>DL2</b> Panel version		

### 3.5 Device configuration information

In the place of letter X, in a factory configuration code, a suitable module number should be given as per the instruction described in the table below.

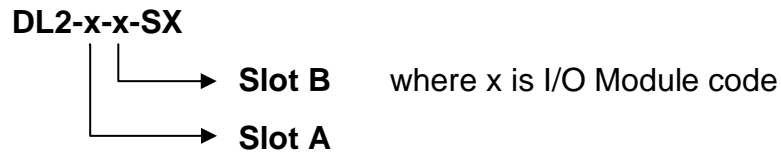

I/O Module code	I/O Module type
11	IN6I(24V)
12	IN6I
23	IN6T
41	IN6V
53	IN6
55	IN4SG
61	IN6D
62	IN3D
71	2RS485(24V)
72	2RS485
75	1HRT
81	OUT6RL
91	OUT3
95	PSBATT

For example:

- device with 6 TC temperature inputs and 6 relay outputs has code:

**DL2-23-81**

- device with 6 voltage inputs has code:

**DL2-41-00**

Number 00 in this code mean, that in the device is only one module (it is installed on SLOT A).

Hardware configuration data may also be verified from the device level in the window [Information about the device](#).

The device is configured by the manufacturer to customer's order. A list of individual modules and their detailed descriptions are given in chapter [DL2 AVAILABLE I/O MODULES](#).

### 3.6 Galvanic separation in the device

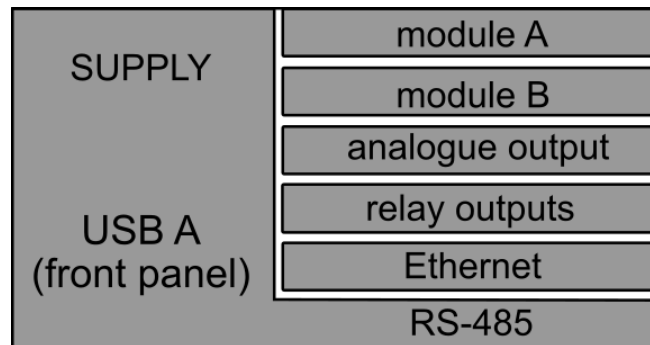

*Fig. 3.1 Galvanic separation in DL2 (functional separation 500VAC @ 1min)*

## 4 DL2 AVAILABLE I/O MODULES

Individual electrical connection diagrams are given in section [ELECTRICAL INSTALLATION](#).

### 4.1 DL2 base set

Each DL2 device is composed of:

- housing,
- front panel with touchscreen colour LCD, LED diode and USB port (type - A),
- the basic M module, which is made up of:
  - 4 solid state relays,
  - one 4-20 mA analog output,
  - Ethernet port,
  - RS-485 communication interface connector,
  - Power supply from 24 VDC.

Depending on the client needs, in the device can be installed up to two input/output modules. Detailed technical descriptions of individual modules are given in section [TECHNICAL SPECIFICATIONS](#).

### 4.2 IN6I(24V) – six channel 0-20mA or 4-20mA input type module

- standard current loop inputs 0-20mA or 4-20mA for passive or active transducers (internal 24 VDC voltage source for loop power supply),
- linear current measurement within the range or sub-range of -20 .. +20 mA,
- galvanic separation from the remaining device circuits, no separation among the input channels,
- each input has a separate four-pole plug-in terminal block,
- two colour LED informing about the module's operating status.

### 4.3 IN6I – six channel 0-20mA or 4-20mA input type module

- standard current loop inputs 0-20mA or 4-20mA for active transducers (no internal 24 VDC voltage source for loop power supply),
- linear current measurement within the range or sub-range of -20 .. +20 mA,
- galvanic separation from the remaining device circuits, no separation among the input channels,
- each input has a separate four-pole plug-in terminal block,
- two colour LED informing about the module's operating status.

### 4.4 IN6T - six-channel temperature module

- Inputs configurable for temperature measurement,
- temperature measurements with Pt, Ni, Cu, KTY sensors,
- temperature measurements with thermocouples,
- compensation of the reference junction with a constant value or measurement with a another channel,
- linear voltage measurement in the range or sub-range of -140 .. +140 mV
- linear measurement of resistance in the range or sub-range of 0 .. 4500  $\Omega$ ,



- galvanic separation from other circuits of the device, no separation between input channels,
- each input has a four-terminal plug-type terminal block,
- two-color LED indicating the module operating status.

#### **4.5 IN6V – six channel voltage type input module**

- standard voltage type inputs: 0-10V, 2-10V, 0-5V, and 1-5V,
- linear measurement of the voltage within the range or sub-range -10 .. +10 V,
- galvanic separation from the remaining device circuits, no separation among the input channels,
- each input has a separate four-pole plug-in terminal block,
- two colour LED informing about the module's operating status.

#### **4.1 IN6 - six-channel universal analog input module**

- Inputs IN1, IN2, IN3 configurable for temperature measurement,
- Inputs IN4, IN5, IN6 configurable to measure analog signals,
- temperature measurements with Pt, Ni, Cu, KTY sensors,
- temperature measurements with thermocouples,
- compensation of the reference junction with a constant value or measurement with a different channel,
- linear current measurement in the range or sub-range 0/4 .. 20 mA,
- linear voltage measurement in the range or sub-range of -140 .. +140 mV, -10 .. +10 V,
- linear measurement of resistance in the range or sub-range of 0 .. 4000  $\Omega$ ,
- galvanic separation from other circuits of the device, no separation between input channels,
- each input has a four-terminal plug-type terminal block,
- two-color LED indicating the module operating status.

#### **4.2 IN4SG – four channel strain gauge input module**

- measurement of the signals from strain gauges,
- strain gauges power supply 5 VDC,
- input signal range -30 .. +30 mV,
- ability to connect from 1 to 4 strain gauges,
- ability to connect from 1 to 4 zero binary signals (tare),
- 24 VDC reset pulse level (10-36 VDC range),
- reset of each channel separately or all channels simultaneously,
- ability to connect strain gauges in a half-bridge and a quarter-bridge configuration (optional, contact with the manufacturer required),
- each input has a separate four-pole plug-in terminal block,
- two colour LED informing about the module's operating status.

#### **4.3 IN3D – three-channel binary input module**

- designed for frequency measurement, pulse counting or two-state operation (possibility of tracking binary signal short circuit / open),
- measurement of frequencies in the range 0,02 .. 12 500 Hz (pulse counting 0 .. 100 Hz),
- 0 .. 4 VDC / 5,5 .. 34 VDC (3,6 mA) according to EN61131-2,

- cooperation with a passive pulse transmitter (contact, transistor in OC configuration), source of voltage or current pulses,
- galvanic separation from other device circuits, no separation between input channels,
- each input has a four-terminal plug-type connector,
- two-color LED indicating the status of the module's operation.

#### **4.4 IN6D – six channel binary inputs module**

- dedicated to measure frequency, pulse counting or state tracking,
- frequency range of 0.1 .. 1000 Hz (pulse counting in range 0 .. 100 Hz),
- 0 .. 4 VDC / 5.5 .. 34 VDC (3.6 mA) according to EN61131-2 characteristics,
- other switching current level at 0.45mA, 1.55mA or 2.44mA can be selected with jumpers located on the module PCB,
- accepts passive pulse transmitter (contact or transistor configuration OC), the source voltage or current pulses,
- galvanic separation from the remaining device circuits, no separation among the input channels,
- each input has a separate three-pole plug-in terminal block,
- each input has a LED to indicate the input state level,
- two colour LED informing about the module's operating status.

#### **4.5 2RS485(24V) – two RS485 port input module (Modbus RTU Master)**

- developed to read process values from instruments and sensors over the RS-485 bus according to the Modbus RTU protocol,
- up to 25 digital values can be read by one module, available formats: unsigned or signed 16 bit or 32 bit integer, signed 64 bit integer, 32 bit or 64 bit floating point,
- 2 independent and galvanically separated RS485 ports,
- each port has a four-pole plug-in terminal block,
- extra 24 VDC /max 200 mA voltage source power supply for external transducers,
- two colour LED informing about the module's operating status.

#### **4.6 2RS485 – two RS485 port input module (Modbus RTU Master)**

- developed to read process values from instruments and sensors over the RS-485 bus according to the Modbus RTU protocol,
- up to 25 digital values can be read by one module, available formats: unsigned or signed 16 bit or 32 bit integer, signed 64 bit integer, 32 bit or 64 bit floating point,
- 2 independent and galvanically separated RS485 ports,
- each port has a four-pole plug-in terminal block,
- two colour LED informing about the module's operating status.

#### **4.7 1HRT – HART (4-20 mA) port input module**

- HART port, reading passive or active transducers (4-20 mA current loop), internal 24 VDC voltage source for loop power supply,
- the module can operate in the multidrop mode (max. 15 devices),
- the device can operate as a Primary Master or as a Secondary Master (compatible with rev 4, rev 5, rev 6, rev 7),
- possibility of reading and recording up to 25 variable values (max. 15 devices) with one module,

- reading the Long Address (rev 5, rev 6, rev 7),
- changing the Short Address (rev 4, rev 5, rev 5, rev 7),
- reading the unique identifier frame (test),
- 250  $\Omega$  internal resistor (disabled by default, resistor can be enabled in the settings menu),
- galvanic separation from the remaining device circuits, no separation among connectors,
- six four-pole plug-in terminal blocks (internal parallel connection between terminals),
- two colour LED informing about the module's operating status.

#### **4.8 OUT6RL – six channel relay outputs module**

- galvanically separated from each other 24 VAC or 36 VDC,
- 0.5 A solid state relays (SSR),
- each port has a four-pole plug-in terminal block,
- two colour LED informing about the module's operating status.

#### **4.9 OUT3 – three channel analogue outputs module**

- universal type analogue outputs, each can work as an active current loop source in the ranges: 0-20 mA, 4-20 mA, 0-24 mA or as an voltage source in the ranges: 0-5 V, 0-10 V,
- 12 bits D/A converter resolution,
- each channel has two four-pole plug-in terminal blocks, one is for connecting the current loop receiver, the other one for the voltage receiver (it is not possible to use both current and voltage source at the same time for the channel),
- two colour LED informing about the module's operating status.

#### **4.10 PSBATT – module for operation with a back-up battery**

- supplying the device with NiMH storage batteries in the event of voltage break (backup) or periodic operation of the device with battery power supply,
- operating time from 1 to 20 hours (depending on the number and types of installed I/O modules),
- two colour LED informing about the module's operating status.

Note: The maximum number of PSBATT modules in the device: 1.

From April 1, 2020, the PSBATT module is manufactured only in version 1.2. Version 1.2 of the module is not backward compatible. The Operating Manual contains information on connecting and configuring the module only in version 1.2. Technical details about the module in version 1.0 and in version 1.1 are available from the Manufacturer. Version 1.0 and 1.1 of the module is not visible in the Hardware configuration in the [Information about the device](#) window (the "-----" sign and the red color of the bar is displayed) and in the [I/O](#) settings window (the "-----" sign is displayed).

#### **CAUTION**

If module IN6I(24V) or 2RS485(24V) installed and operating as a power supply source for external devices, ambient temperature is limited to 0 .. +40 °C. In all other configurations the ambient temperature range is 0 .. +50 °C.

## 5 MECHANICAL INSTALLATION



**Prior to the commencement of any assembly work, read carefully the information concerning safety described in section [SAFETY INFORMATION](#).**

DL2 is a panel-mounted device. It can be mounted into panels at least 1 mm thick. Before installation, a 138<sup>(+1)</sup> mm X 68<sup>(+0,7)</sup> mm rectangular opening must be cut out in the panel. The mounting depth of the device (with connected terminals) is 127 mm. In order to ensure easy installation of electrical connections, it is recommended to leave an extra space of approx. 30 mm behind the device.

When installing the recorder in the panel opening, the seal between the housing frame and the panel have to be fitted. After inserting the recorder into panel opening, the fixing clamps should be latched on both side walls and then tighten the screws. With the removable screw terminal block, one can first install electrical connections and then fit the recorder.

	DL2
Mounting cut-out in panel – width	138 <sup>(+1,1)</sup> mm
Mounting cut-out in panel – height	68 <sup>(+0,7)</sup> mm
Depth of mounting with connectors	127 mm

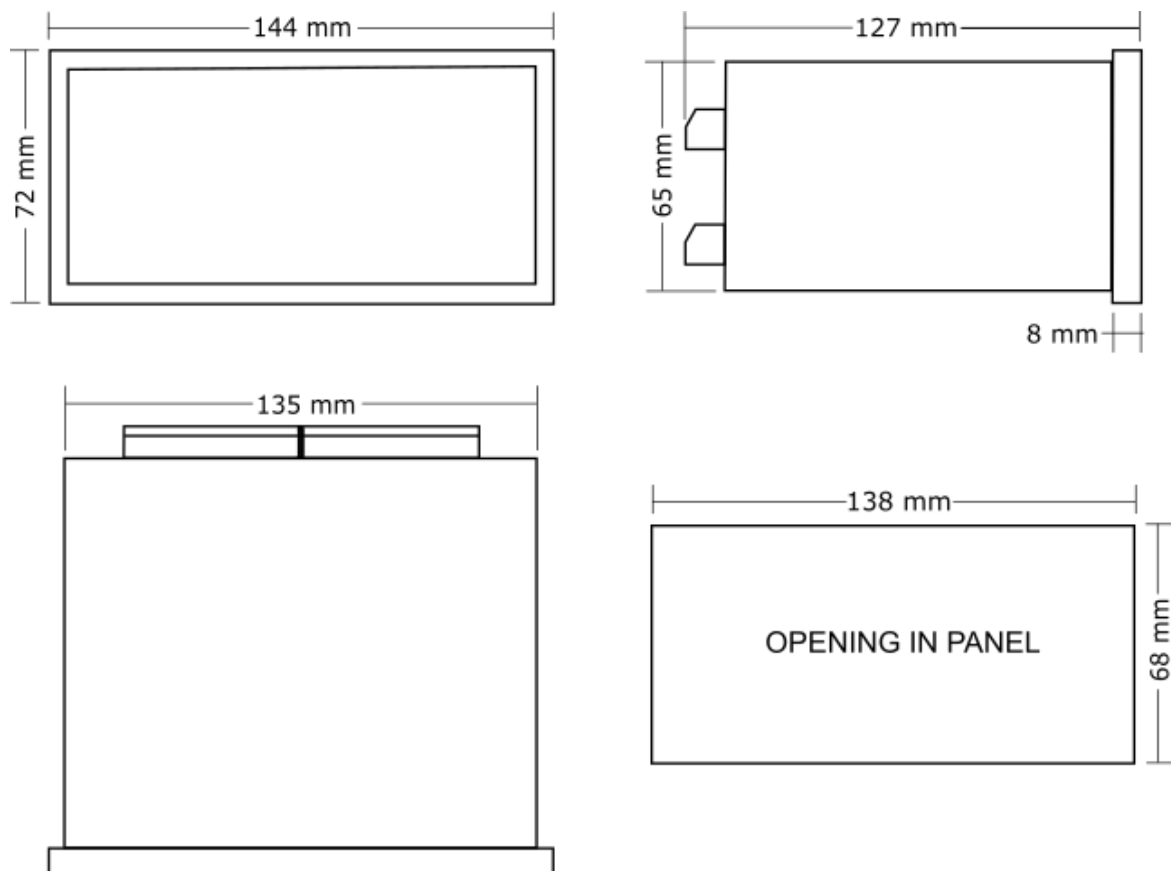

*Fig. 5.1 Housing dimensions of DL2 device and cut-out dimensions of an assembly panel.*



**The device cannot be exposed to direct heat generated by other equipment.  
When assembled, the operating device cannot be affected by interference from other components (contacts, power relays, inverters).**

## 6 ELECTRICAL INSTALLATION

**!** Prior the commencement of any connection works, read carefully the information concerning safety described in section [SAFETY INFORMATION](#).

Power supply and all signal wires are connected to plug-in screw terminals, situated at the rear panel of the device. Maximum wires cross-section area is 1.5 mm<sup>2</sup>. Both wire and cord cables can be used. Wires should be stripped 8 mm to 10 mm at the end. If cables with a larger cross-section are used, it is recommended to use an intermediate terminal block in the measurement cabinet between the facility wiring and the recorder.

DL2 is a modular device. Always M module is installed (see: section [DL2 base set](#)). Depending on the requirements, up to two I/O modules marked A and B are installed (see detailed information in section [DL2 AVAILABLE I/O MODULES](#)).

The drawing below shows a rear panel of the base module M and two modules with six channels. Depending on the device version the rear panel may look different.

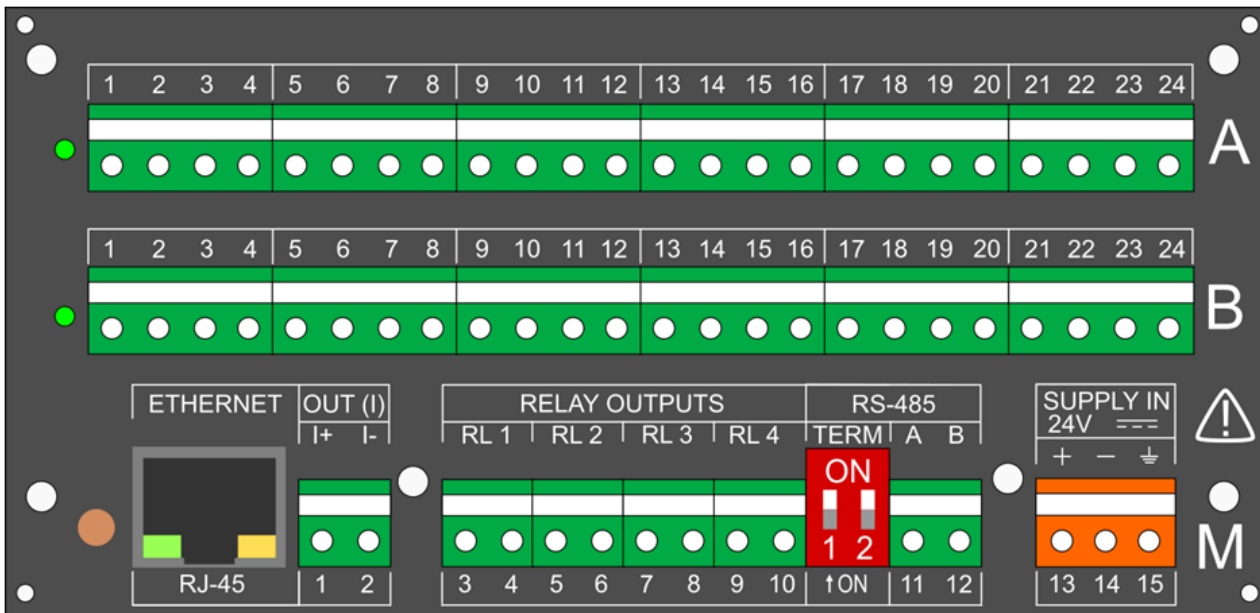
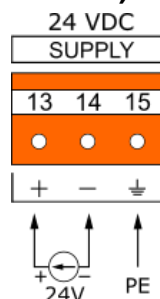

Fig. 6.1 Rear panel view of DL2 device.

### 6.1 Power supply connection (Module M)



The device requires 24 VDC power supply at minimum 12 W. If supplied from 230/110 VAC, it is recommended to use high efficiency industrial switching power supply at minimum 15 W of delivered power.



To ensure safety, the recorder's supply must satisfy the conditions applicable to lower voltage sources SELV (Safety Extra Low-Voltage), supplied with the 24 VDC as per the IEC60950-1.

In order to eliminate interference, it is recommended to connect the ground wire to the terminal block (terminal no. 15). It is so called functional ground. This connection is not required due to safety requirements.

If the PSBATT module is installed, it is forbidden to connect the power supply to the M module – details in section [PSBATT – back-up battery module](#).

Power consumption depends on the quantity and type of input and output modules. It should be taken into account that the maximum permissible ambient temperature depends on device configuration, details are described in section [TECHNICAL SPECIFICATION](#).

## 6.2 I/O modules – wiring diagrams (SLOT A and B)

Detailed information concerning individual modules is given in section [DL2 AVAILABLE I/O MODULES](#).

### 6.2.1 IN6I(24V) – six channel 0-20mA or 4-20mA input type module

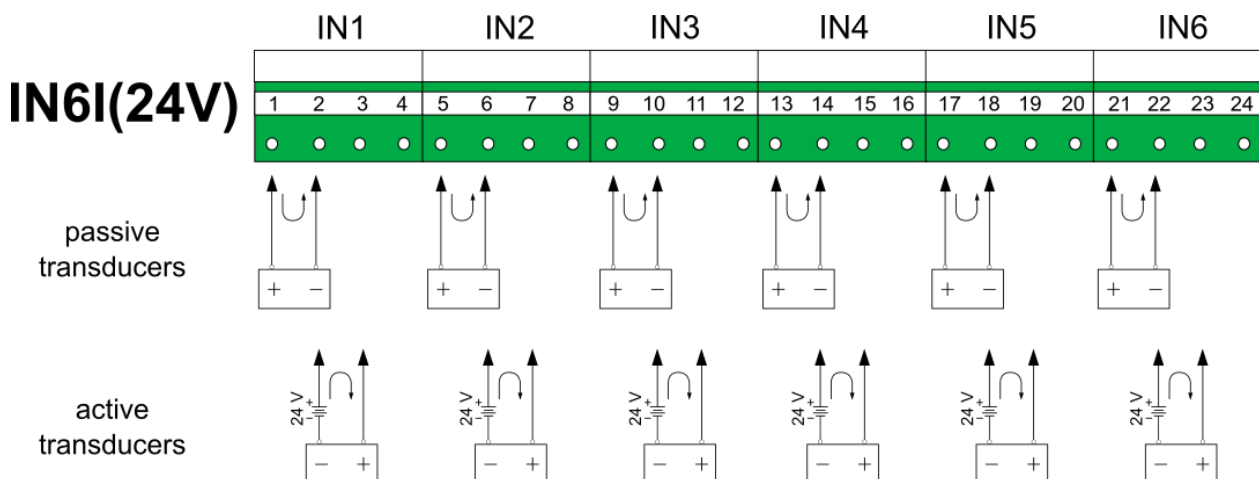

Terminal No						Description
1	5	9	13	17	21	<b>+24V OUT (22 mA max)</b> Transducer power supply. Each output is protected by resetable polymer 50 mA fuse.
2	6	10	14	18	22	<b>I+</b> Current loop signal input (+)
3	7	11	15	19	23	<b>I-</b> Current loop signal input (-)
4	8	12	16	20	24	<b>GND A</b> Signal ground

**Note:**

If screened cable is used to connect transducer, then GND A terminal may be used to connect the screen. But it is more recommended to connect screen to functional ground or metal cabinet ground (PE).

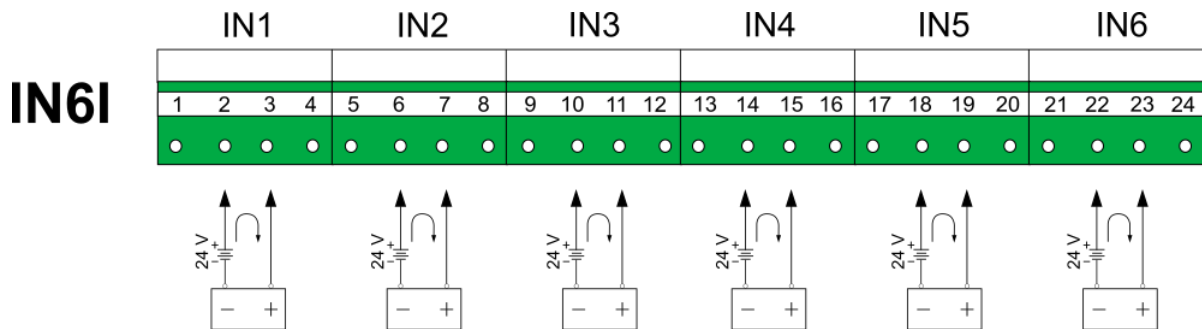
**6.2.2 IN6I – six channel 0-20mA or 4-20mA input type module**

Terminal No						Description
1	5	9	13	17	21	<b>Not used</b>
2	6	10	14	18	22	<b>I+</b> Current loop signal input (+)
3	7	11	15	19	23	<b>I-</b> Current loop signal input (-)
4	8	12	16	20	24	<b>GND A</b> Signal ground

**Note:**

If screened cable is used to connect transducer, then GND A terminal may be used to connect the screen. But it is more recommended to connect screen to functional ground or e.g. metal cabinet ground (PE).

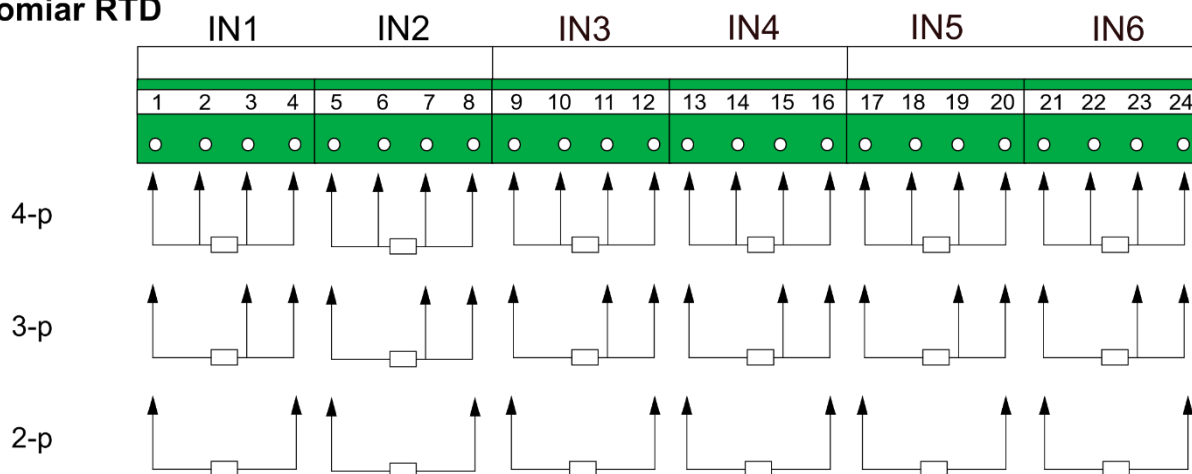
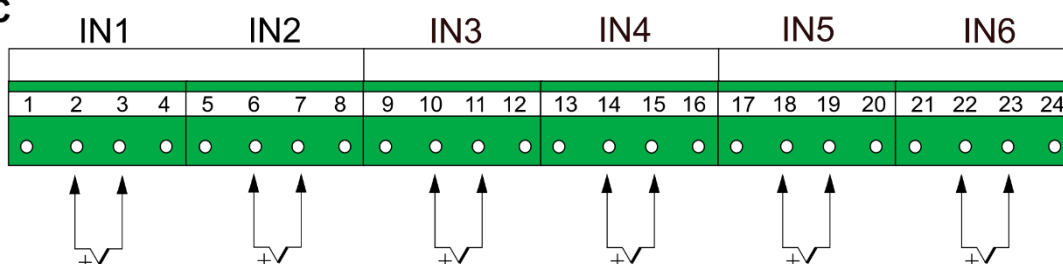

**6.2.3 IN6T - six-channel temperature module**
**IN6T**
**Pomiar RTD**

**Pomiar TC**

Terminal No						Description
1	5	9	13	17	21	<b>I+</b> Current output for 4-w, 3-w, 2-w
2	6	10	14	18	22	<b>U+</b> Voltage sens input for 4-w, 3-w, 2-w Voltage signal for TC sensors, input (+)
3	7	11	15	19	23	<b>U- / I+</b> Voltage sens input for 4-w, 2-w Voltage sens input and current output for 3-w Voltage signal for TC sensors, input (-)
4	8	12	16	20	24	<b>I- / 2*I-</b> Current return for 4-w, 2-w Double current return for 3-w

**Note:**

IN6T card is factory calibrated for 2 and 3 wire connection.

At the user's request, it is possible to calibrate in a 4-wire connection

If screened cable is used to connect sensor, then GND A terminal may be used to connect the screen. But it is more recommended to connect screen to functional ground or e.g. metal cabinet ground (PE).

For precision temperature measurements the proper cold junction temperature measurement have to be considered. The device during typical operation heats up about 10 °C, what has influence on the device terminals temperature. It should be considered to move

the wiring compensation cables to extra terminals in the cabinet with stable temperature. The cold junction temperature should be measured with external temperature sensor (e.g. Pt100) at the external terminals then.

If the TC sensors are connected directly to the module's terminal block, it is possible to compensate the cold junction temperature with an internal sensor. The temperature of the cold junction measured by the internal sensor is assigned to the virtual measuring inputs (CJC °C and CJC °F). The same unit for the measured temperature and the temperature of the cold junction must be set.

### 6.2.4 IN6V – six channel voltage type input module

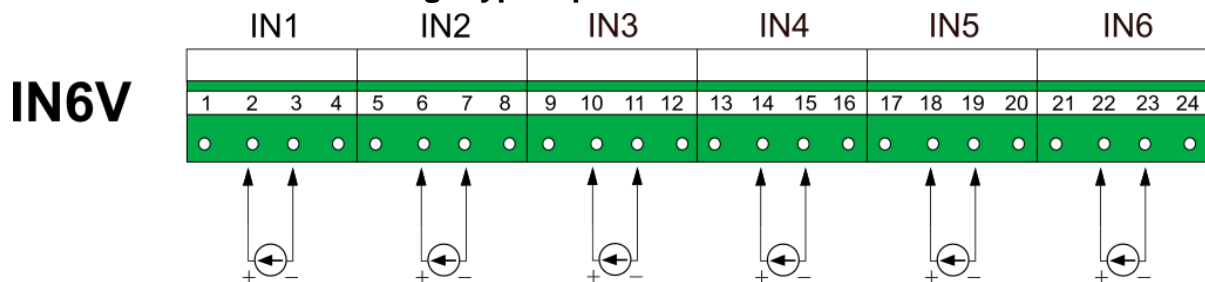

Terminal No						Description
1	5	9	13	17	21	<b>Not used</b>
2	6	10	14	18	22	<b>V+</b> Voltage signal input (+)
3	7	11	15	19	23	<b>V-</b> Voltage signal input (-)
4	8	12	16	20	24	<b>GND A</b> Signal ground

**Note:**

If screened cable is used to connect sensor, then GND A terminal may be used to connect the screen. But it is more recommended to connect screen to functional ground or e.g. metal cabinet ground (PE).

6.2.5 IN6 - six-channel universal analog input module

**IN6**

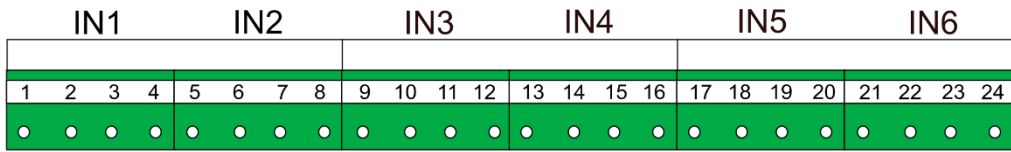

**measurement I**

active transducer

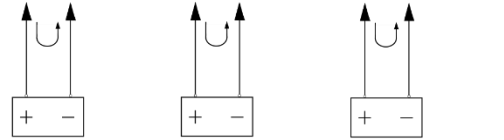

passive transducer

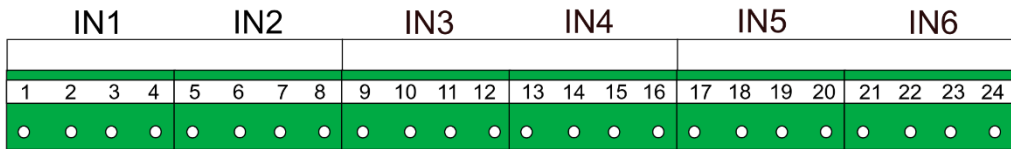
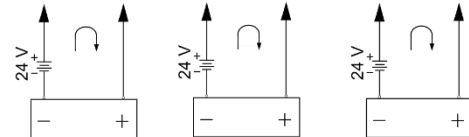

**measurement V**

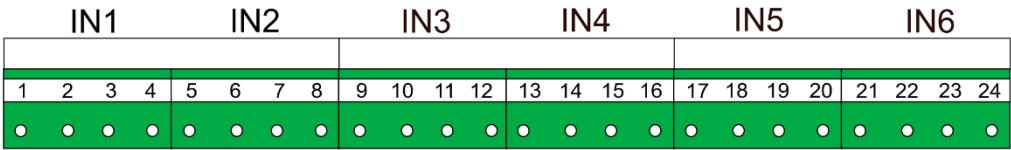
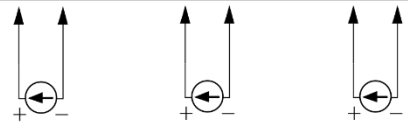

4-wire

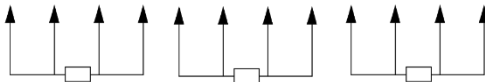

3-wire

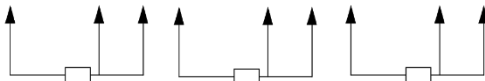

2-wire



**measurement RTD**

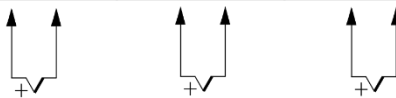
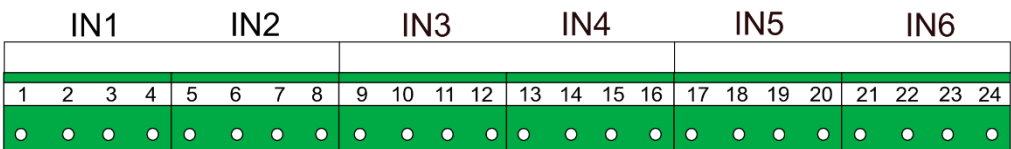

**measurement TC**

Terminal No			Description
1	5	9	<b>I+</b> Current output for 4-w, 3-w, 2-wire
2	6	10	<b>U+ / mV+</b> Voltage sens input for 4-w, 3-w, 2-wire Voltage signal for TC sensors, input (+)
3	7	11	<b>U- / I+ / mV-</b> Voltage sens input for 4-w, 2-wire Voltage sens input and current output for 3-wire Voltage signal for TC sensors, input (-)
4	8	12	<b>I- / 2*I-</b> Current return for 4-w, 2-wire Double current return for 3-wire
13	17	21	<b>+24V OUT (22 mA max)</b> Power supply of the transducer. Each output is protected by a 50 mA resettable polymer fuse
14	18	22	<b>I+</b> Current loop signal input (+)
15	19	23	<b>V+</b> Voltage signal $\pm 10$ V input (+)
16	20	24	<b>I-</b> Current loop signal input (-) <b>V-</b> Voltage signal $\pm 10$ V input (-)

**Note:**

IN6T card is factory calibrated for 2 and 3 wire connection.

At the user's request, it is possible to calibrate in a 4-wire connection.

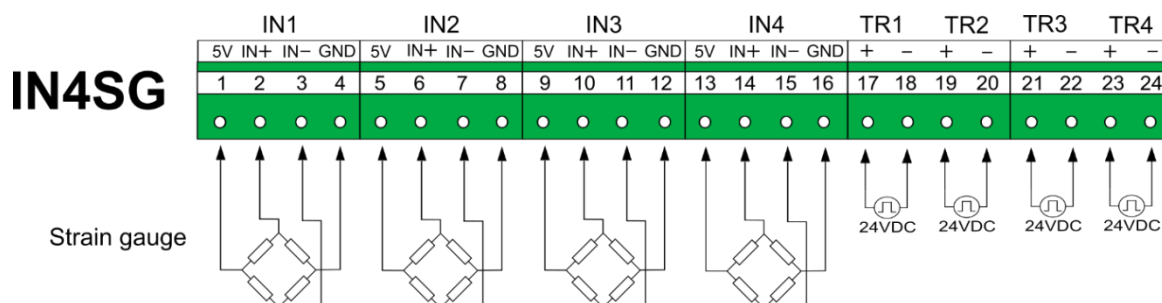
**6.2.6 IN4SG – four channel strain gauge inputs module**

Numer zacisku				Opis				
1	5	9	13					+5 VDC strain gauge power supply
2	6	10	14					IN+ input signal (+)
3	7	11	15					IN- input signal (-)
4	8	12	16					GND strain gauge power supply
				17	19	21	23	+ digital (tare) input signal
				18	20	22	24	- digital (tare) input signal

**Note:**

Strain gauge in half-bridge or quarter-bridge configuration may also be connected optionally. Please contact manufacturer.

The signal TR1, TR2, TR3 and TR4 will reset channel 1, 2, 3, 4, respectively, or when activating the logical sum, any TR input will reset all channels simultaneously.

### 6.2.7 IN3D – three-channel binary input module

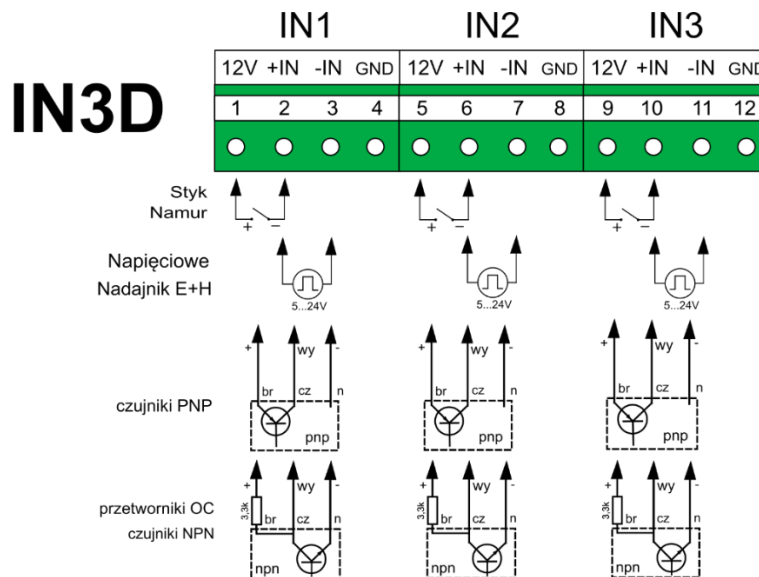

Terminal Description:

Terminal No			Description
1	5	9	<b>+12V OUT (48 mA max )</b> Transducer power supply. Outputs are protected by common resettable polymer 50 mA fuse.
2	6	10	<b>+IN</b> Pulse signal input.
3	7	11	<b>-IN</b> Pulse signal input.
4	8	12	<b>GND A</b> Signal ground

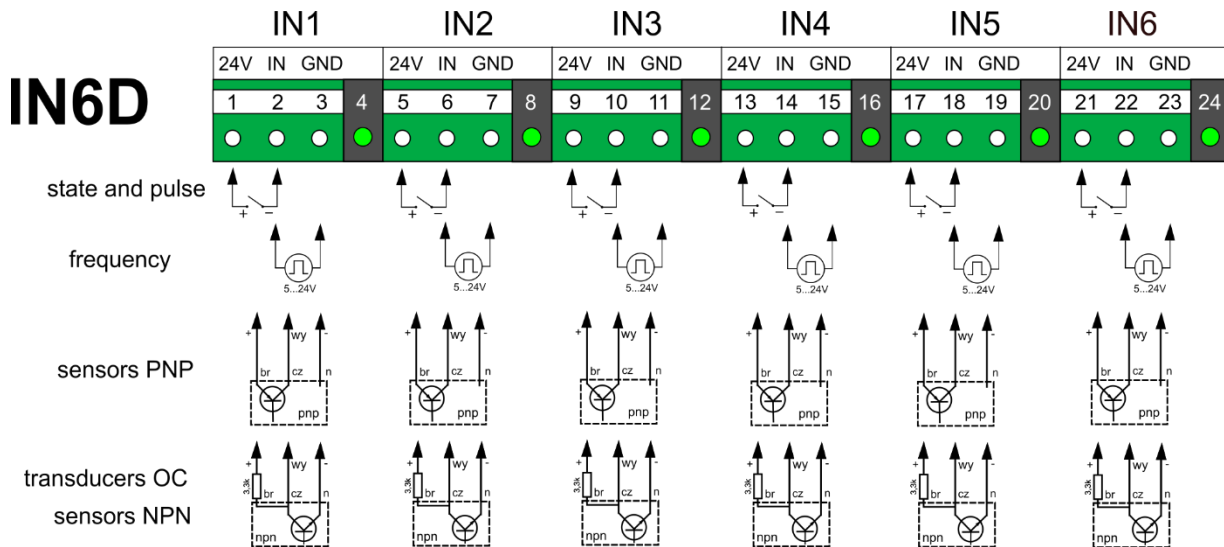
**6.2.8 IN6D – six channel binary inputs module**

Terminal No						Description
1	5	9	13	17	21	<b>+24V OUT (48 mA max (6x 8 mA))</b> Transducer power supply. Outputs are protected by common resettable polymer 50 mA fuse.
2	6	10	14	18	22	<b>PULS IN</b> Pulse signal input. Current limit in table below.
3	7	11	15	19	23	<b>GND A</b> Signal ground
LED	LED	LED	LED	LED	LED	LED indicator of the input state.

**Note:**

The module IN6D standard current limit for inputs is set at 3.6mA. In special cases, it is possible to change the limit value using the jumpers located on the module board inside the device. Available settings are in the table below. The setting apply to all six channels.

J1	J2	I MAX
		0,3mA
•		0,9mA
	•	3,0mA
•	•	3,6mA

To change the settings it is necessary to open the rear panel of device, remove and again install the module. This work should only be carried out by properly qualified staff, carefully and with keeping safety rules.

If screened cable is used to connect the pulse transmitter, then screen should be connected to functional ground or metal cabinet ground (PE).

## 6.2.9 2RS485(24V) – two RS485 port input module (Modbus RTU Master) 2RS485(24V)

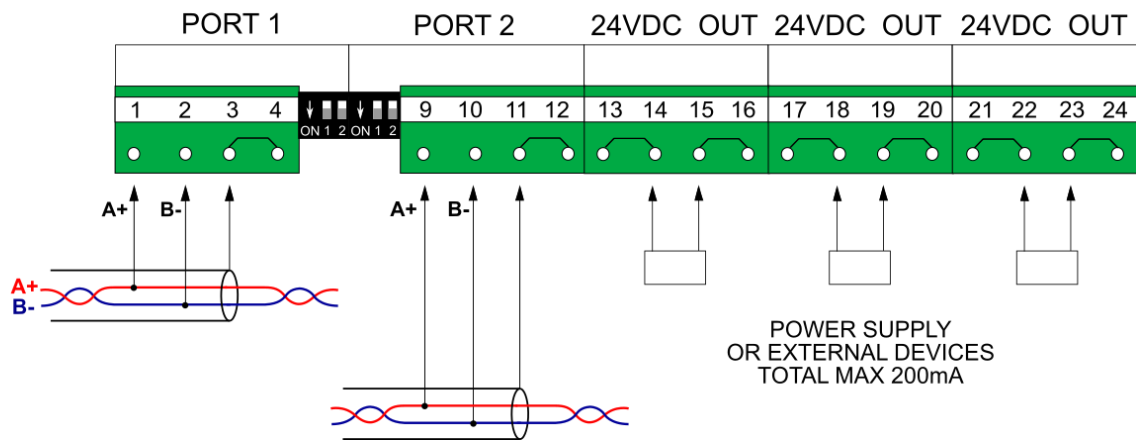

Terminal No			Description			
1	T1	9			<b>A+</b> RS485 terminal A	
2	T1	10			<b>B-</b> RS485 terminal B	
3	T2	11			<b>G</b> Signal ground	
4	T2	12			<b>G</b> Signal ground	
			13 14	17 18	21 22	<b>+24 VDC OUT (200 mA max)</b> Auxiliary transducers power supply (+). Terminals 13, 14, 17, 18, 21, 22 internally shorted. Overcurrent protected.
			15 16	19 20	23 24	<b>-24 VDC OUT (200 mA max)</b> Auxiliary transducers power supply (-). Terminals 15, 16, 19, 20, 23, 24 internally shorted.

**Note:**

Port 1 and port 2 are galvanically separated.

Auxiliary 24 VDC output is galvanically separated from Port 1 and Port 2.

More details on wiring RS-485 are described below for [port RS-485 in module M](#).

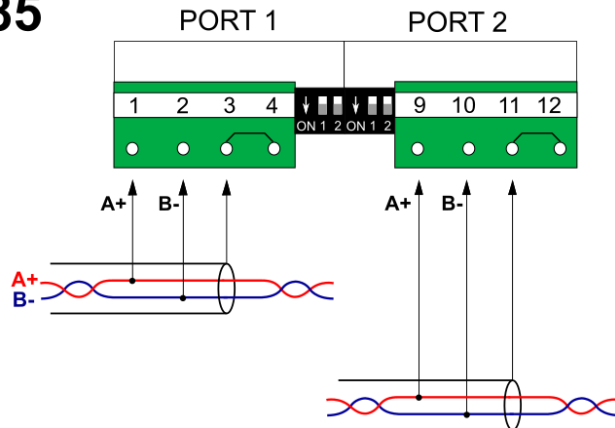
**6.2.10 2RS485 – two RS485 port input module (Modbus RTU Master)**
**2RS485**

Terminal No				Description
1	T1	9		<b>A+</b> RS485 terminal A
2	T1	10		<b>B-</b> RS485 terminal B
3	T2	11		<b>G</b> Signal ground
4	T2	12		<b>G</b> Signal ground

**Note:**

Port 1 and port 2 are galvanically separated.

More details on wiring RS-485 are described below for [port RS-485 in module M](#).

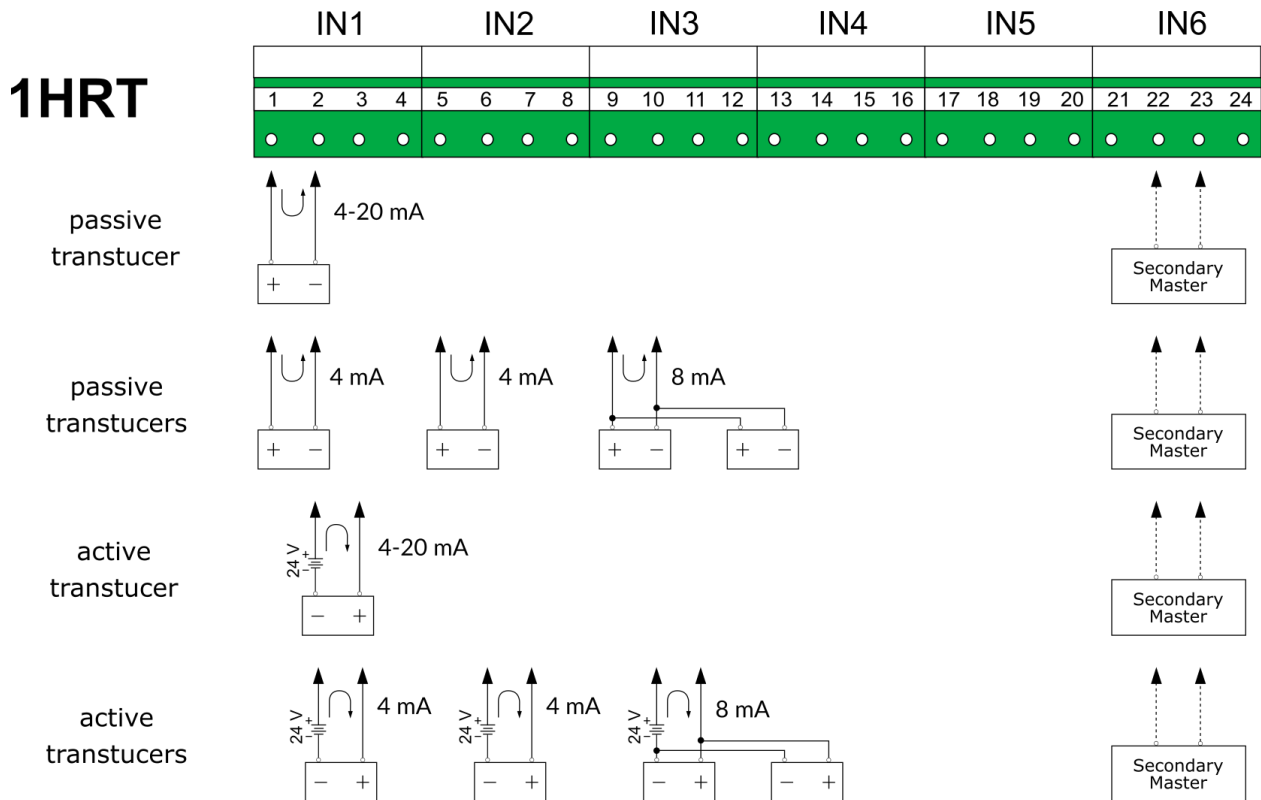

**6.2.11 1HRT – HART (4-20 mA) port input module**

Terminal No						Description
1	5	9	13	17	21	<b>+24V OUT</b> Transducer power supply. Inputs are protected by common resettable polymer fuse.
2	6	10	14	18	22	<b>HRT+</b> HART+ signal input (passive transducer and active transducer). Connecting the device in Secondary Master mode.
3	7	11	15	19	23	<b>HRT-</b> HART- signal input (active transducer and passive transducer powered from an external power source). Connecting the device in Secondary Master mode.
4	8	12	16	20	24	<b>SHIELD</b> Connecting the cable shield.

**Note:**

The module has an internal 250 Ω resistor (disabled by default, resistor can be enabled in the I/O menu). In the event of a power failure, the resistor is disabled.

The module terminal blocks are connected in parallel internally. It is possible to create a multidrop connection using an connection on line or using the module's connectors.

The device can be configured as Primary Master or as Secondary Master - turning on/off the internal resistor depending on the application should be taken into account.

It is possible to connect the cable shield to the module terminal blocks. If the device is mounted in a metal cabinet, it is recommended to connect the screen directly to the cabinet, by passing the module connector. The screen must be connected to GND at both ends of the cable. If there is a risk of equalizing current flowing through the screen, the screen should be grounded on one side only (at the device).

### 6.2.12 OUT6RL – six channel relay outputs module

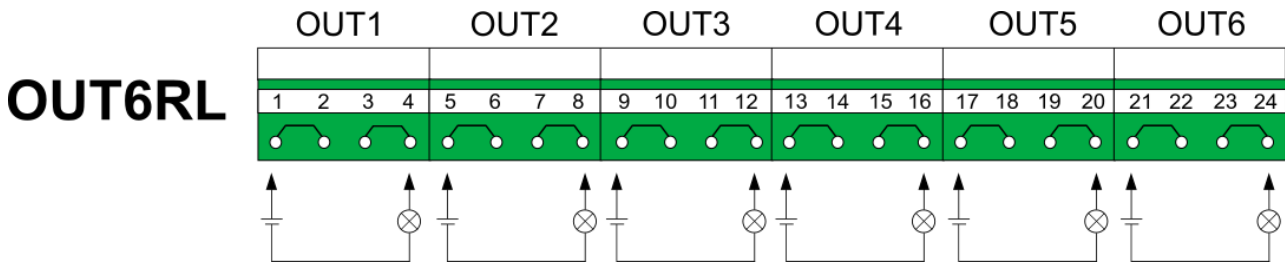

Fig. 6.16 Wiring diagram of receivers to relay outputs of OUT6RL module.

Terminal No						Description
1	5	9	13	17	21	Relay terminal output (AC/DC)
2	6	10	14	18	22	
3	7	11	15	19	23	Relay terminal output (AC/DC)
4	8	12	16	20	24	

**Note:**

Outputs 1 - 6 are galvanically separated.

### 6.2.13 OUT3 – three channel analogue outputs module

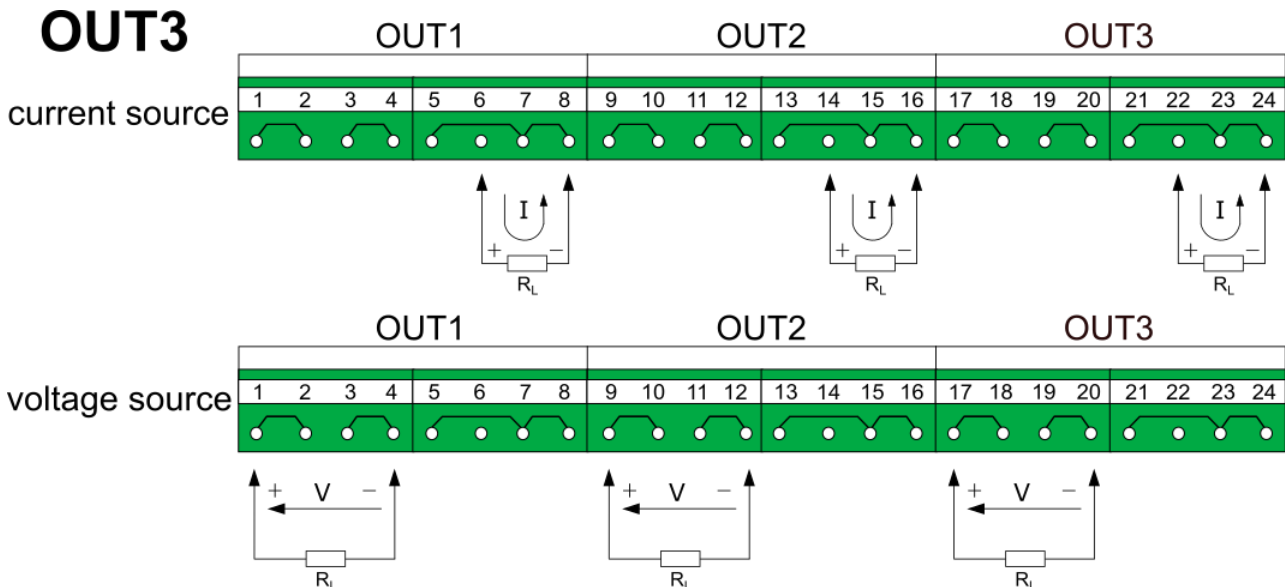

Terminal No					Description
1		9		17	<b>V+</b> Voltage signal 0 .. +10 V output (+)
2		10		18	
3		11		19	<b>V-</b> Voltage signal 0 .. +10 V output (-)
4		12		20	
	6		14		<b>I+</b> Current loop signal source 0-24 mA output (+)
	5		13		<b>I- / GND A</b> Current loop signal source 0-24 mA output (-) This terminal is also signal ground.
	7		15		
	8		16		

**Note:**

Outputs 1, 2 and 3 are galvanically separated. Each output may be configured to one mode only, either voltage or current source. Current output active - it must not be powered from an external voltage source.

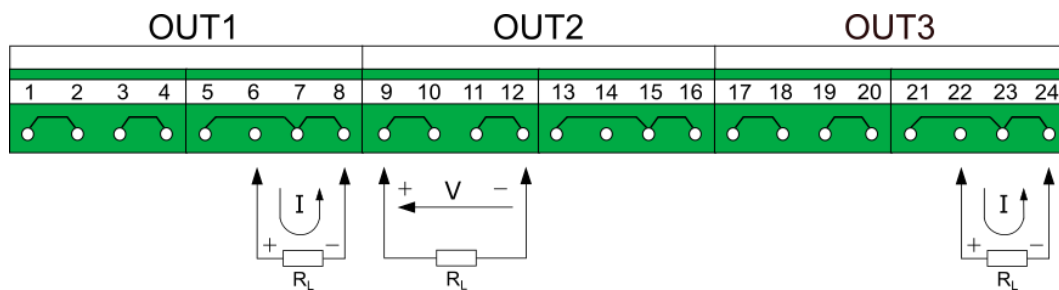

*The correct way wiring OUT3 module.*

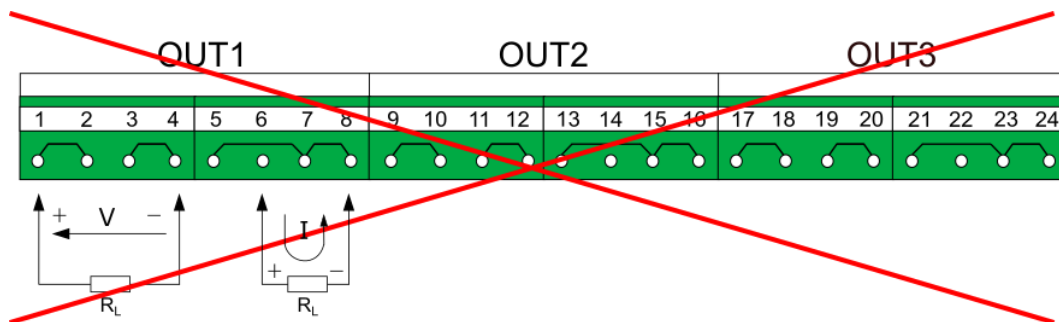

*The incorrect way wiring OUT3 module.*

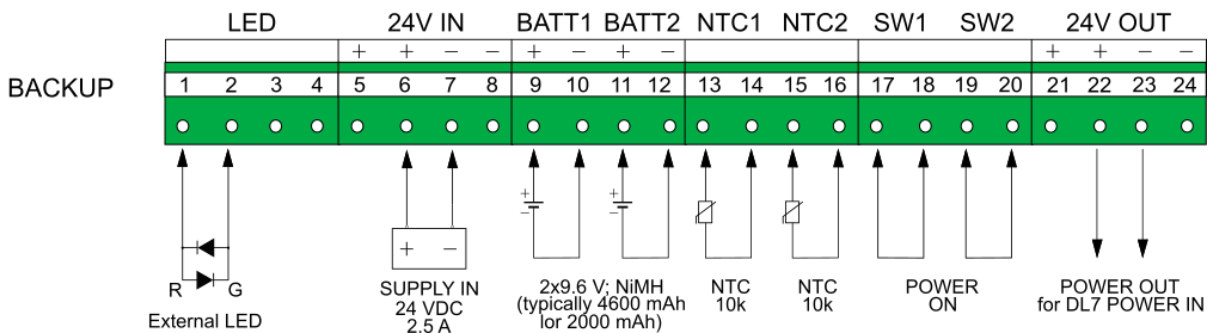
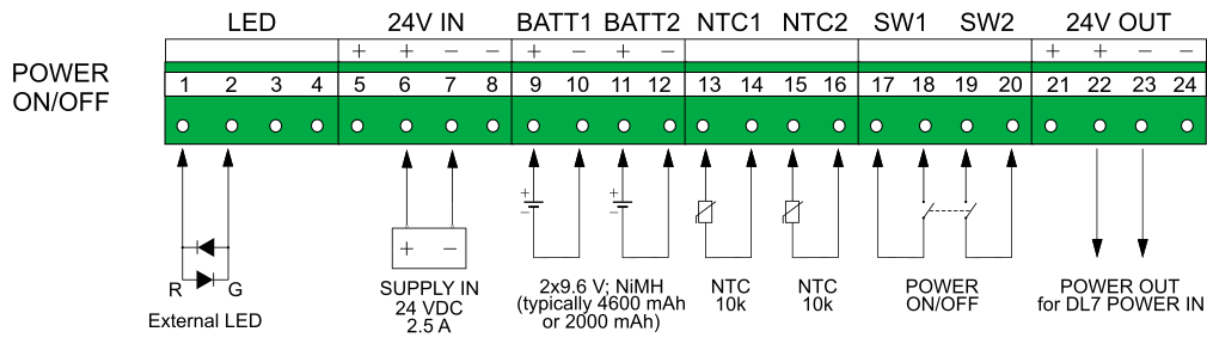
**6.2.14 PSBATT – back-up battery module**
**PSBATT**

Terminal No	Description
1	<b>R</b> Connecting an external LED
2	<b>G</b> Connecting an external LED
3	<b>Not used</b>
4	<b>Not used</b>
5	<b>+24 VDC SUPPLY IN (2.5 A max)</b>
6	Module PSBATT and device power supply (+)
7	<b>-24 VDC SUPPLY IN (2.5 A max)</b>
8	Module PSBATT and device power supply (-)
9	<b>2x9.6 V NiMH (typically 4600 mAh or 2000 mAh)</b>
11	Connecting NiMH storage batteries (+), BATT1 package
10	<b>2x9.6 V NiMH (typically 4600 mAh or 2000 mAh)</b>
12	Connecting NiMH storage batteries (-), BATT2 package
13	<b>NTC1</b>
14	Connecting a NTC thermistor for BATT1
15	<b>NTC2</b>
16	Connecting a NTC thermistor for BATT2
17	<b>Power ON/OFF</b>
18	Connecting an external power switch

<b>19</b> <b>20</b>	
<b>17</b> <b>18</b> <b>19</b> <b>20</b>	<b>Backup</b> Terminals 17 and 18 and terminals 19 and 20 must be shorted externally
<b>21</b> <b>22</b>	<b>+24 VDC POWER OUT (1 A max)</b> Power output signal (+), must be connected to terminal 13 on the M module
<b>23</b> <b>24</b>	<b>-24 VDC POWER OUT (1 A max)</b> Power output signal (-), must be connected to terminal 14 on the M module

**Note:**

24 V IN and 24 V OUT are not galvanically separated.

The two-color LED indicates the module operating status and battery status:

- short pulses in green colour (0.5 s on / 1.5 s off):  
pre-charging (battery discharged),
- pulses in green colour (0.5 s on / 0.5 s off):  
main charging,
- long pulses in green colour (1.5 s on / 0.5 s off):  
recharging (battery charged),
- green color of the diode (continuous signal):  
the battery is fully charged (supplying the device from a battery),
- pulses in red colour (0.5 s on / 0.5 s off):  
battery heavily discharged (supplying the device from a battery),
- red color of the diode (continuous signal):  
failure state, e.g. failure of temperature sensor or battery, temperature exceeding.

If the PSBATT module is installed, it is forbidden to connect the power supply to the M module (terminals 13, 14, 15). The power supply must be connected only to the PSBATT module (24V IN). The power supply output signal must be connected from the PSBATT (24V OUT) module to terminals 13, 14 on the M module. Terminal 15 on the M module should be connected to GND or PE. Use only dedicated power supply.

The double external switch is used to power the device, it does not disconnect battery charging.

From April 1, 2020, the PSBATT module is manufactured only in version 1.2. Version 1.2 of the module is not backward compatible. The presented way of connecting signals applies only to version 1.2 of the module. To connect signals to module in version 1.0 or in version 1.1, contact the Manufacturer.

### 6.3 Wiring diagrams for module M

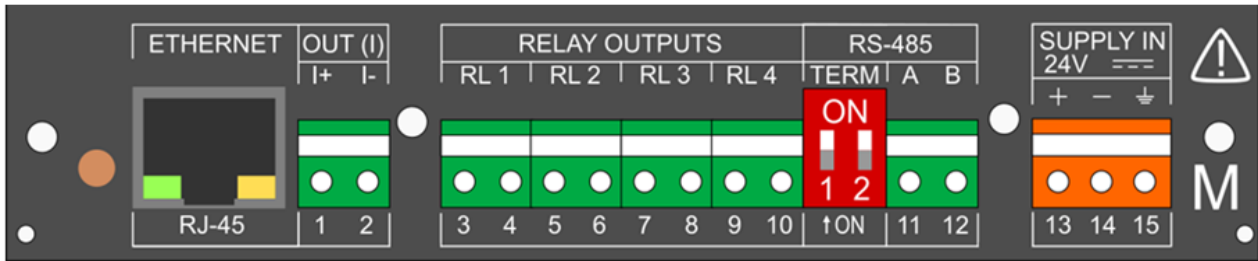
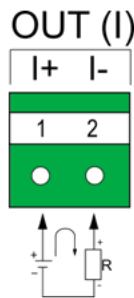

Fig.6.2 Model view of the rear plate of DL2 (module M).

#### 6.3.1 Wiring diagram for the analog output



**Note:**

Current source passive – requires external voltage source.

#### 6.3.2 Wiring diagram for the relay outputs

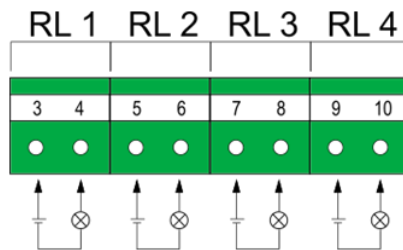

#### 6.3.3 Connection of RS-485 data transmission line

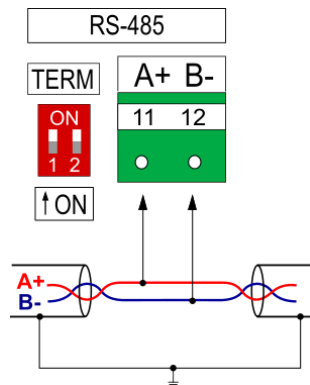

**Note:**

The device RS-485 receiver/driver allows connection of up to 32 devices.

An RS485-MODBUS configuration must have one trunk cable, along which devices are connected, directly (daisy chaining) or by short derivation cables.

The maximum bus length depends on the baud rate, the cable (gauge, capacitance or characteristic impedance), the number of loads on the daisy chain. For a 9600 Baud Rate and 0.125 mm<sup>2</sup> (AWG26) or wider gauge, the maximum length is 1200 m. The derivations must be short, never more than 20 m.

To minimize the reflections from the end of the RS-485 cable it is required to place a line termination near each of the 2 ends of the bus. The device has an internal termination system, activated by DIP switch on the left side of the terminal block. The correct operation of the terminator requires setting both switches in the same position.

The 'common' wire should be used for all RS-485 ports. For DL2 device as a common signal the power supply '-' (terminal no. 14) or functional ground (terminal no. 15) have to be used.

**6.3.4 Ethernet port**

Ethernet (100Base-T) port is located in the rear panel of the device. Outputs connections are compliant with EIA/TIA-568A/B. A LAN cable (Patch Cord) ended with RJ-45 plug may be connected to this port.

## 7 FRONT PANEL AND MAIN FUNCTION BUTTONS

### 7.1 Front panel

A 4" LCD touch screen is built into the front panel of the device, which is the basic tool of communication with the user.

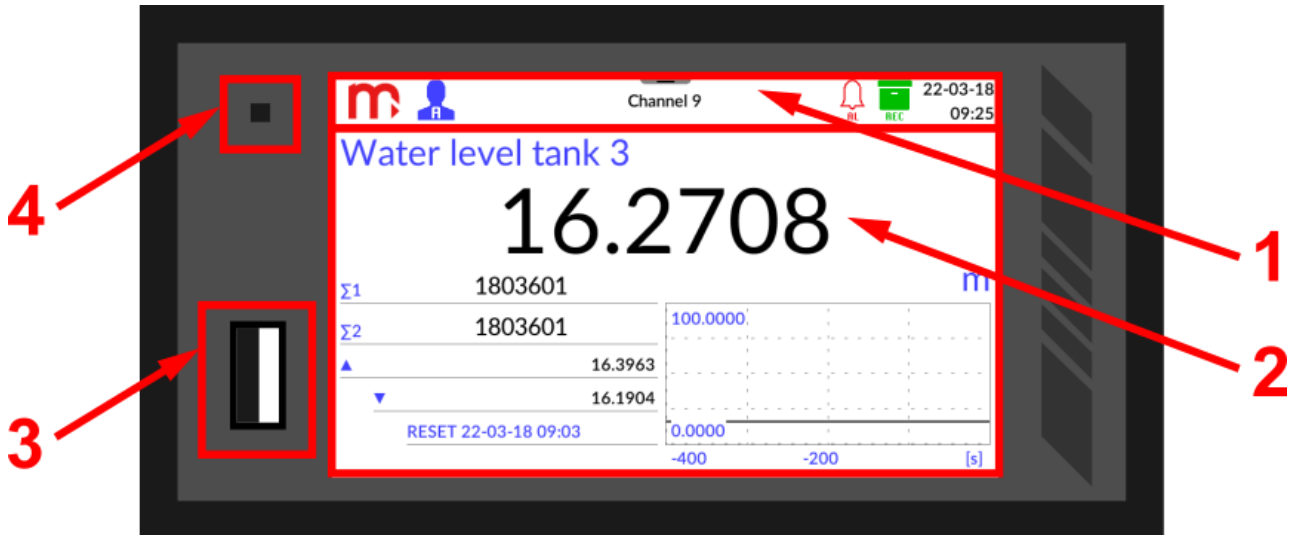

Fig. 7.1 Front panel of the DL2 device.

The display is consists of:

1. [Title bar](#) with function icons; touching the screen at the height of the title bar shows up [menu bar](#) with the icons, which are used to switch between screens.
2. Main screen used to present the results of all the measurements, display all function windows and upload data (using the keyboard).

Additionally, the front panel contains:

3. USB port enables connecting an external mass storage device (a USB flash memory) to move data stored in the internal memory from the device to a PC.
4. LED signals processes using colors:
  - green – lights when new archive is creating,
  - blue – lights when the device is starting; when screen is dimmed on 0%; during reading/saving the file (flashing during copying data between internal memory and USB flash memory), during taking a screenshot,
  - red – informs about errors.



**Do not use sharp or metal tools to operate the touch screen. Improper use may result in damage on the display.**



### 7.1.1 Title bar



Fig. 7.2 Title bar.

The title bar is located in the top part of the screen and has mainly the informative function, but there are also function icons.



Manufacturer logo: function icon, tap to make screenshot to internal memory of the device (more information in section [Print screen](#)).



Information about the login status: function icon, clicking log out the user (more information in section [Login](#)).



Trendy

The title of the currently open window (descriptions of individual windows are presented in section [USER SCREENS](#)).



Alarm status, flashing/illuminating icon indicates an alarm: function icon, clicking toggles to Alarms window (more information in section [Alarms](#)).



Archive status: displayed icon informs that the archiving process is enabled (more information in section [Archive](#)).

15-01-18  
14:54

Date and time read from the RTC clock.

### 7.1.2 Menu bar

Touching the screen at the height of the title bar shows up the menu bar. It enables navigations between windows.



Fig. 7.3 Touching the screen at the height of the title bar shows up menu bar.



Switch back to the previous screen of the single result (or the last active channel)



Open window: Information about the device (more information in section [Information about the device](#))



Open window: Results Tables (more information in section [Results Tables](#))



Open window: Trends (more information in section [Trends](#))



Open window: Archive (more information in section [Archive](#))



Open window: Main Menu (more information in section [Main Menu](#))



Open window: Alarms (more information in section [Alarms](#))



Switch into the next screen of single result (or the first active channel)

## 8 FIRST START UP AND KEY ACTIVITIES

Having plugged the device to power supply it will automatically switch on after the elapse of several seconds.

The device has pre-configured hardware and set English language. Before configuring the device, first login to appropriate level of access.

### 8.1 Access control, login and change of user password

#### 8.1.1 Access control

In the DL2 data recorded, access control module was applied aimed at limiting the possibility of changing the parameters of work of the device and copying the data from the device by unauthorized users or operator.

It is realised through 5 access control levels:

- **No logged in user**  
Standard operating mode enabling screen viewing. This level does not allow any modification of the parameters and prohibits access to the device using the USB stick. The operator may not open any configuration windows, except for the login window. This level can be turned off (more information in the section [changing the password](#)).
- **User**  
The first level of the authorised user. It enables viewing of the device settings, archive control (start, stop, new archive file), resetting the values - minimum and maximum, zeroing the totalizers and copying the files through the USB port. In addition, user may take screenshots.
- **Administrator**  
The second level of the authorised user. It enables the same functions which has User level. In addition, this level enables viewing and modifications of the device settings and deleting the archive files. Administrator may deprive the User of the ability to control the archive operation.
- **Service**  
This level is accessible solely for the authorised technicians of Metronic AKP.
- **Factory**  
The level is accessible solely for the manufacturer.



#### 8.1.2 Login

To login to the relevant access level tap the  icon on menu bar. Next, from the drop down list select the suitable access level and enter the password using the screen password keyboard. Press **Login** button to confirm the operation.

During the first login, default passwords have to be used:

Access level	Password
User	0
Administrator	1

After the initial login, the passwords can be changed (more in section [Changing the password](#)).

Logout, regardless of the user access level, is automatic after the elapse of 5 minutes of idleness. To log out after a shorter period, tap the icon  (User) or  (Administrator) on the **Title bar** and press **Logout** button.

Previous log out the user to login to another access level is not required.

### 8.1.3 Changing the password

Password can be changed in the Login window. After logging in, with using the old password, select the level for which the passwords is changed from the drop down list. Next, enter the new password twice and confirm the operation using the **Change** button.



**!** **The password keyboard allows to use only small and block letters and special characters. It is not possible to use letters specific to a particular language.**  
**■ The option is available in all other keyboards of the device.**

It is possible to save a lack of password for selected control level - press on the field *New password* and *Confirm new password* and do not enter any characters. Then, confirm the operation (**Change**). If there is no password saved for the User, the access level *No logged in user* is automatically removed - there is no possibility to log out from the User level.

In addition to the change of the password, the Administrator can also change the User password without the need to know the previous password. If the Administrator's password is forgotten, please contact the Metronic AKP Service.

## 8.2 Change of the language

To change the language, in the first step user should login as the Administrator (information in section [Login](#)).

To change the language, press the button  on menu bar and then select  icon. In the next step, select the **General** tab. From the drop down list **Language** select one of the seven available languages: EN (ENGLISH), DE (DEUTSCH), ES (ESPAÑOL), FR (FRANÇAIS), IT (ITALIANO), PL (POLSKI), PT (PORTUGUÊS).



Having selected the language and confirming the selection , click on any icon from the menu bar (other than the Main Menu icon). There will be a message with the request to confirm the intention to make changes.

After delivery, the device has the English language set. After selecting the **Restore factory settings** option, the device will start in English (more information in section [Factory settings](#)).

## 8.3 Recommended order for configuration of the device

Individual parameters of the device can be configured in any order; however, some of the settings depend on other parameters. For this reason, it is recommend the following order for the first configuration of the device:

### 1. Change of the language

 →  → **General** tab → **Language** → 

### 2. Input/output settings

#### 2.1 Configuration of installed I/O modules

→ → configuration of installed I/O modules →

## 2.2 Configuration of Modbus TCP (Client) communication settings

→ → **Ethernet** tab → configuration →

→ → **Modbus TCP** tab → **Servers** tab → configuration → **Register** tab → → configuration →

## 3. Channel settings

→ → **Inputs** tab → configuration → **General** tab → configuration →

## 4. Alarms

→ → **Alarm 1** tab → configuration → **Alarm 2** tab → configuration →

## 5. Totalizers

→ →  $\Sigma 1$  tab → configuration →  $\Sigma 2$  tab → configuration →

## 6. Recording measurement results

### 6.1 Channels

→ → **General** tab → Archiving (/) →

### 6.2 Alarms

→ → **Alarm 1/Alarm 2** tab → Log event (/) → Change the frequency of archiving (/) →

### 6.3 Totalizers

→ →  $\Sigma 1/\Sigma 2$  tab → Archiving (/) →

### 6.4 Archive

→ → configuration →

## 7. RS-485 transmission

→ → **RS485 COM** tab → configuration →

## 8. Ethernet transmission

→ → **Ethernet** tab → configuration →

## 9. Displaying the results

→ → **Result Tables** tab → configuration →

→ → **Trends** tab → configuration →

## 10. E-mail notification

→ → **Alarm 1/Alarm 2** tab → E-mail Notification (/) →

→ →  $\Sigma 1/\Sigma 2$  tab → E-mail Notification (/) →

→ → **Ethernet** tab → configuration →

*The device must be connected to the network. Before configuring the E-mail tab, configure the Ethernet tab and reset the device*

 →  → **E-mail** tab → **General** tab → *configuration* → **Recipients** tab →  
→ *configuration* → **Cyclic report** tab → *configuration* →

#### 11. Display (display brightness/background colour/screen saver parameters)

 →  → **Display** tab → *configuration* →

#### 12. Changing administrator password



 →  → **Change password** →

After configuring and confirming the selection , click on any icon from the menu bar (other than the Main Menu icon). There will be a message with the request to confirm the intention to make changes. Starting archive process in the Archive window: select the  button from menu bar and then press the **START** button.

Detailed information regarding programming of the individual settings is given in section [PROGRAMMING SETTINGS](#).

Due to the use of the same interface, device configuration using the computer software *DL2 Config.exe* takes place in the same way as configuration from the device level. After completing the configuration using the computer, record the setting file \*.par using a USB flash memory, as described in the next section.

### 8.4 Reading and saving files using the USB port

To read or write files using the USB flash memory select the  button from menu bar and then the  icon. On the left side of the screen, there is a window with a list of archive files and screenshots. On the right side of the screen, there are function buttons.

Plug in the flash memory. Afterwards, a window with setting files (\*.par) located on USB flash memory is displayed. Flash memory must be in FAT format (not in NTFS format). Do not connect hard disk drive. Compatibility of all USB memory devices is not guaranteed. Do not use an extension cable when connecting a USB memory device. This may cause radio interference with other devices.

Using the function buttons it is possible to: copy data from the device to a portable USB flash memory (archives, screenshots, settings), copy files from the USB flash drive (settings files) and delete archive files from the device (except for current archives).

To record the current archive files, select the **Save current archives to USB** option. As a result three archive files, i.e. data, totalizer and event files will be stored to the pendrive.

If another file is to be recorded on a USB drive, first select the relevant file from the list. The selected file will be marked in blue. Then, choose the option: **Save selected on USB**.

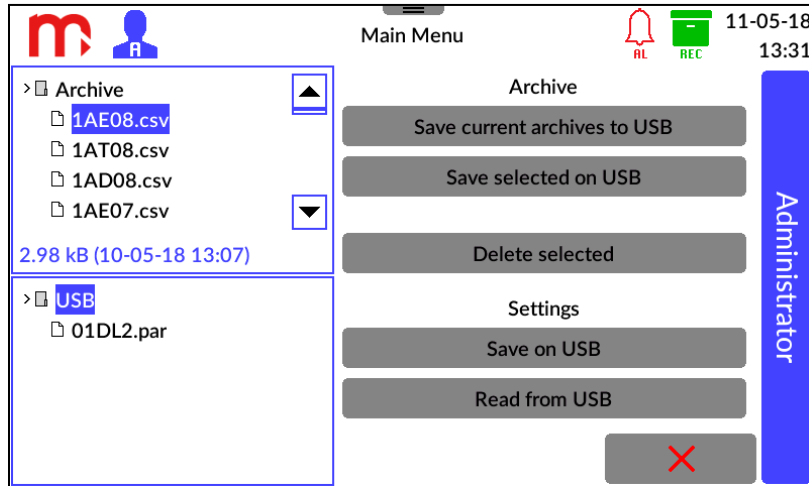

Fig. 8.1 An example view of the 'USB' window.

The duration of the process is signalled by the blue diode on the face plate. After correct storage of the date, a suitable message is displayed.

To erase a selected archive file, first select the required file from the list and then select the **Delete selected** option.

**! Removing the USB flash memory before the writing process is complete may result in damaging of the recorded files.**

There is also a possibility:

- saving settings on a USB flash memory (select the option **Save on USB**)
- reading settings from a USB flash memory (select relevant file from the list and then choose the option **Read from USB**).



If new settings file from the flash memory is read, the device will automatically reboot.

## 8.5 Factory settings

To restore the device to the factory settings, first login as the Administrator.

**! Before selecting the factory settings option, it is recommended to save the previous settings on the USB flash memory. Otherwise, the settings will be lost. Files in the archive will not be deleted.**

- **The administrator password will not be changed. The user's password will be restored to default.**

In the next step, select the  button from menu bar and then the  icon. Select the **Service** tab and then **Restore Factory Settings** button. The device will automatically reboot with factory settings in the used language (if the language change has been saved).

Previous settings will be lost, in particular I/O settings – all inputs / outputs will be turned off. Configure the settings of the device starting from I/O setting, in the order described in the section [Recommended order for configuration of the device](#) or load previous setting ([Reading and saving files using the USB port](#)).

## 9 TECHNICAL SPECIFICATIONS

<b>Front panel</b>	
Type of display	LCD TFT 4" 800 px X 480 px LED backlight
Display size	86.4 mm X 52.5 mm
Keyboard	resistive touch panel
Additional indication	LED RGB
<b>USB Port - front panel</b>	
Version	USB 2.0 (with limited functionality, for connection of FLASH storage)
Connector type	USB standard 'A' type socket
<b>Ethernet Port - rear panel</b>	
Interface	10/100Base-T Ethernet
Connector type	RJ-45
Transmission protocol	Server WWW, Modbus TCP Client/Server ICMP (ping)
<b>Modbus TCP Client</b>	
Number of connections opened simultaneously	Max 20
Number of read values	Max 30
<b>Modbus TCP Server</b>	
Number of connections opened simultaneously	Max 4
<b>RS-485 Serial Port - rear panel</b>	
Signals output on terminal block	A(+), B(-)
Galvanic separation	None
Maximum load	32 receivers/transmitters
Transmission protocol	Modbus RTU Slave
Transmission rate	1.2, 2.4, 4.8, 9.6, 19.2, 38.4, 57.6, 115.2 kbps
Parity control	Even, Odd, None
Frame	1 start bit, 8 data bits, 1 stop bit
Maximum length of line	1200 m
Internal terminating resistor	V <sub>cc</sub> -A(+)-B(-)-G: 390 Ω - 220 Ω - 390 Ω (activated by DIP-switches)
Maximum differential voltage A(+), B(-)	-7 V ... +12 V
Minimum output signal of transmitter	1.5 V (at R <sub>L</sub> = 54 Ω)
Minimum sensitivity of receiver	200 mV / R <sub>IN</sub> = 12 kΩ
Minimum impedance of data transmission line	54 Ω
Short-circuit/thermal protection	Yes/Yes
<b>Internal data memory</b>	
Memory type	Flash
Capacity	2 GB
Estimated recording time for recording speed every 5 s for 16 measuring channels	ca. 2 years
<b>Supply</b>	
Supply voltage	24 VDC (20 .. 30 VDC)
Maximum power consumption	12 W
Security	The internal delay fuse 3.15 A, the exchange only by the service company

<b>Electrical connections (terminal connectors)</b>	
Type	screw terminal connectors
Wire cross section	solid and flexible: 0.14 .. 1.5 mm <sup>2</sup> flexible with bootlace ferrule 0.25 .. 1.5 mm <sup>2</sup> AWG 30 .. 14
<b>Mechanical Dimensions – Housing</b>	
Type of housing	panel mount, nonflammable plastic material „Noryl“
Dimensions with connectors (w X h X d)	144 mm X 72 mm X 127 mm
Dimensions of panel cut-out (w X h)	138 <sup>+1</sup> mm X 68 <sup>+0,7</sup> mm
Maximum panel thickness	5 mm
Weight	0.5 kg
Protection class	IP30 on front panel side IP20 on rear panel side
<b>Environmental conditions</b>	
Ambient temperature	0 .. +50 °C or 0 .. +40 °C depends on the device hardware configuration <sup>(1)</sup>
Relative humidity	5 .. 95% (without steam condensation)
Maximum altitude	< 2000 m above sea level
Storage temperature	-30 .. +70 °C
Degree of pollution	PD2
EMC	EMC Directive 2014/30/EU EN 61326-1:2013 Table 2 (immunity) EN 61326-1:2013 Class A (emission)
RoHS	RoHS Directive 2011/65/EU
<sup>(1)</sup> If module IN6I(24V) or 2RS485(24V) installed and operating as a power supply source for external devices, ambient temperature is limited to 0 .. +40 °C. In all other configurations the ambient temperature range is 0 .. +50 °C.	

<b>Analog output 4-20mA</b>	
Output signal	4-20 mA (3.6 .. 22 mA)
Current loop supply	no (external supply required)
Maximum voltage between I+ and I-	28 VDC
Minimum supply current loop voltage	9 VDC (R <sub>L</sub> = 0 Ω)
Loop resistance (R <sub>L</sub> )	0 .. 500 Ω
Galvanic isolation to supply voltage	250 VAC; 1500 VAC for 1 minute
<b>Relay outputs</b>	
Number of outputs	4
Outputs type	Solid state relays
Maximum voltage	60 V AC/DC
Maximum load current	0.1 A

### I/O Modules

<b>IN6I(24V); IN6I – 0-20mA or 4-20mA input type module</b>	
Number of inputs	6
Measuring range	0–20 mA; 4–20 mA; (the actual range -22 .. 22 mA)
Resolution	0.001 mA
Measurement accuracy (T <sub>a</sub> = +25 °C)	< ±0,1% measuring range (typically < ±0.05%)
Temperature drift	< ±0.02% /°C measuring range
Input resistance	12 Ω ±10%
Maximum input voltage	± 40 VDC



Input protection	Polymer fuse 50 mA
Transducers powered from device: <ul style="list-style-type: none"> <li>• module IN6I(24V)</li> <li>• module IN6I</li> </ul>	24 VDC $\pm$ 15% / max 22 mA None
Galvanic separation from the other circuits	250 VAC; 1500 VAC for 1 minute
Galvanic separation between channels	None

### IN6T – six-channel temperature input module

Number of inputs	6
Sensor type	<ul style="list-style-type: none"> <li>• Resistance (Table below); 0 .. 4500 <math>\Omega</math></li> <li>• Thermocouple (Table below); <math>\pm</math>140 mV</li> </ul>
Maximum input voltage	$\pm$ 30 VDC
Galvanic separation from the other circuits	250 VAC; 1500 VAC for 1 minute
Galvanic separation between channels	None
Input resistance	>100 k $\Omega$
Specifications for input type RTD	
Sensor connection type	2-wire; 3-wire; 4-wire
Sensor current	200 $\mu$ A
Measuring range	0 .. 4500 $\Omega$
Resolution	0.05 $\Omega$
Wire resistance compensation in the 3-wire connection	Automatic
Wire resistance correction in the 2-wire, 3-wire, 4-wire connection	Constant within the range of $-99.99$ .. $+99.99$ $\Omega$
Maximum resistance of the sensor wires	20 $\Omega$
Specifications for input type TC	
Measuring range	$-140$ .. $+140$ mV
Resolution	0.01 mV
Cold junction compensation	<ul style="list-style-type: none"> <li>• Any other temperature measuring channel (in C/ F) or a constant value,</li> <li>• Internal sensor measurement: accuracy <math>\pm</math>2.5 C (value can be calibrated by the user),</li> <li>• For thermocouple B – no compensation</li> </ul>

### IN6V – voltage type input module

Number of inputs	6
Sensor type	<ul style="list-style-type: none"> <li>• 0-10 V (2-10 V, 0-5 V, 1-5 V)</li> <li>• Linear voltage source</li> </ul>
Measuring range	$-10$ .. $+10$ VDC (or sub-range) (the actual range $-11$ .. $+11$ VDC)
Resolution	0.0001 V
Measuring range ( $T_a = +25$ $^{\circ}$ C)	$< \pm$ 0.1% measuring range (typically $< \pm$ 0.05%)
Temperature drift	$< \pm$ 0.02% / $^{\circ}$ C measuring range
Input resistance	>100 k $\Omega$
Maximum input voltage	$\pm$ 40 VDC
Galvanic separation from the other circuits	250 VAC; 1500 VAC for 1 minute
Galvanic separation between channels	None

### IN6 – six-channel universal analog input module

Number of inputs	6
Sensor type	• Resistance (Table below); 0 .. 4500 $\Omega$

	<ul style="list-style-type: none"> <li>• Thermocouple (Table below); <math>\pm 100</math> mV</li> <li>• 0–20mA; 4–20mA (supply loop module)</li> <li>• <math>\pm 10</math>V / 0-10V (2-10V, 0-5V, 1-5V)</li> </ul>
Maximum input voltage	$\pm 30$ VDC
Galvanic separation from the other circuits	250 VAC; 1500 VAC for 1 minute
Galvanic separation between channels	None
<b>Specifications for input type RTD</b>	
Sensor connection type	2-wire; 3-wire; 4-wire
Sensor current	200 $\mu$ A
Measuring range	0 .. 4500 $\Omega$
Resolution	0.05 $\Omega$
Wire resistance compensation in the 3-wire connection	Automatic
Wire resistance correction in the 2-wire, 3-wire, 4-wire connection	Constant within the range of $-99.99$ .. $+99.99$ $\Omega$
Maximum resistance of the sensor wires	20 $\Omega$
<b>Specifications for input type TC</b>	
Measuring range	-140 .. +140 mV
Resolution	0.01 mV
Cold junction compensation	<ul style="list-style-type: none"> <li>• Any other temperature measuring channel (in C/ F) or a constant value,</li> <li>• Internal sensor measurement: accuracy <math>\pm 2.5</math> C (value can be calibrated by the user),</li> <li>• For thermocouple B – no compensation</li> </ul>
<b>Specifications for input type 0-20mA, 4-20mA</b>	
Measuring range	0–20 mA; 4–20 mA; (acceptable range -22 .. 22 mA)
Resolution	0.001 mA
Measurement accuracy ( $T_a = +25$ °C)	$< \pm 0.1\%$ measuring range (typically $< \pm 0.05\%$ )
Temperature drift	$< \pm 0.02\%$ /°C measuring range
Input resistance	12 $\Omega$ $\pm 10\%$
Input protection	Polymer fuse 50 mA
<b>Specifications for input type <math>\pm 10</math>V / 0-10V</b>	
Measuring range	-10 .. +10 VDC (or sub-range) (acceptable range -11 .. +11 VDC)
Resolution	0.0001 V
Measuring range ( $T_a = +25$ °C)	$< \pm 0.1\%$ measuring range (typically $< \pm 0.05\%$ )
Temperature drift	$< \pm 0.02\%$ /°C measuring range
Input resistance	$> 100$ k $\Omega$

<b>IN4SG – four channel strain gauge input module</b>	
Number of analog inputs	4
Number of binary inputs (tare)	4
Sensore type	Strain gauge sensor, strain gauge (quarter-, half-, full-bridge configuration available)
Measuring range	-30 .. +30 mV
Resolution	0,0001 mV
Accuracy	$< \pm 0,1\%$ of 10 mV range (typically $< \pm 0,05\%$ )

Temperature drift	< $\pm 0,01\%$ /°C of 10 mV range
Strain gauge bridge supply voltage	5 VDC
Minimum bridge resistance (4 inputs used)	250 $\Omega$
Minimum bridge resistance (2 inputs used)	125 $\Omega$
Minimum bridge resistance (1 inputs used)	62 $\Omega$
Maximum input voltage	$\pm 40$ VDC
Galvanic separation from the other circuits	250 VAC; 1500 VAC for 1 minute
Galvanic separation between analog channels	none
Binary inputs (tare)	Voltage type activation; 24 VDC/5 mA ( range 10-36 VDC)
Switching level	ca. 6 VDC
Maximum input voltage	$\pm 40$ VDC
Galvanic separation from the other circuits	250 VAC; 1500 VAC for 1 minute
Galvanic separation between binary channels	Yes (functional separation)

<b>IN3D – binary inputs module</b>	
Number of inputs	3
Sensor type:	State tracking Frequency measurement 0.1 .. 12 500 Hz Counting pulses (freq. range 0.. 100 Hz)
Resolution measurement of frequency	0.1 Hz
Measuring range (measurement of frequency)	< $\pm 0.01\%$ measuring range (typically < $\pm 0.005\%$ )
Maximum input voltage	$\pm 28$ VDC
Galvanic separation between channels	None, common GND potential for all inputs
Galvanic separation from supply voltage	400 VAC (functional isolation)
Features	Status detection Pulse counting Frequency measurement
Measuring range	0,02 Hz do 12,5 kHz
Minimum pulse width	20 $\mu$ s (low pass filter off) 5 ms (low pass filter on)
Basic error (for $T_a = 20$ °C)	0,02%
Configuration: OC/contact <sup>(1)</sup>	
Opening state voltage	12 V
Short-circuit current	12 mA
On/off threshold	2,7 V / 2,4 V
<sup>(1)</sup> Default.	
Configuration: voltage input	
Input resistance	>10 k $\Omega$
On/off threshold	2,7 V / 2,4 V
Opening state voltage	12 V
Configuration: Namur	
High impedance state	0,4 .. 1 mA
Low impedance state	2,2 .. 6,5 mA

<b>IN6D – binary inputs module</b>	
Number of inputs	6
Sensor type:	<ul style="list-style-type: none"> <li>• State tracking</li> <li>• Frequency measurement 0.1 .. 1000 Hz</li> <li>• Counting pulses (freq. range 0 .. 100 Hz)</li> </ul>
Resolution measurement of frequency	0.1 Hz
Measuring range (measurement of frequency)	< ±0.01% measuring range (typically < ±0.005%)
Temperature drift (measurement of frequency)	< ±0.002% /°C measuring range
Input resistance	1.2 kΩ ±10%
Input voltage operation (switching level)	0 .. 4 VDC / 5.5 .. 34 VDC (3.6 mA) <sup>(2)</sup> (according to PN-EN61131-2 characteristic)
Maximum input voltage	-0.3 VDC / +36 VDC
Contacts debounce filtering	off / 1 ms / 3 ms
Power supply source for external transducers	24 VDC ±15% / max 50 mA Protected by thermal fuse
Galvanic separation from the other circuits	250 VAC; 1500 VAC for 1 minute
Galvanic separation between channels	None
<sup>(2)</sup> If required, other switching current level at 0.45mA, 1.55mA or 2.44mA can be selected with jumpers located on the module PCB.	

<b>2RS485(24V); 2RS485 – RS485 ports input module (Modbus RTU Master)</b>	
Number of ports	2
Maximum number of process values read	25 (one or both ports in total)
Signals output on terminal block	A(+), B(-), 2x G (G - signal ground)
Maximum bus load	32 receivers / transmitters
Transmission protocol	Modbus RTU Master
Transmission rate	1.2, 2.4, 4.8, 9.6, 19.2, 38.4, 57.6, 115.2 kbps
Parity control	Even, Odd, None
Frame	1 start bit, 8 data bits, 1 stop bit
Galvanic separation	250 VAC; 1500 VAC for 1 minute
Maximum length of line	1200 m
Internal terminating resistor	Vcc-A(+)-B(-)-G: 390 Ω - 220 Ω - 390 Ω (activated by DIP-switches)
Maximum differential voltage A(+), B(-)	-9 V ... +14 V
Minimum output signal of transmitter	1.5 V (at R <sub>L</sub> = 54 Ω)
Minimum sensitivity of receiver	200 mV / R <sub>IN</sub> = 12 kΩ
Minimum impedance of data transmission line	54 Ω
Short-circuit/thermal protection	Yes/Yes
Additional power supply 24 VDC source <ul style="list-style-type: none"> <li>• 2RS485(24V) module</li> <li>• 2RS485 module</li> </ul>	<ul style="list-style-type: none"> <li>• 3 four pole terminal block (+ + - -)</li> <li>• 24 VDC ±15% / max 200 mA</li> <li>• None</li> </ul>

<b>1HRT – HART (4-20 mA) port module</b>	
Transmission protocol	<ul style="list-style-type: none"> <li>• Rev 4, rev 5, rev 6, rev 7</li> <li>• Primary Master or Secondary Master</li> </ul>
Functions	Supported 0, 1, 3, 6, 9 commands: <ul style="list-style-type: none"> <li>• Reading PV, SV, TV, FV and DVC variables</li> <li>• Reading the Long Address (rev 5, rev 6, rev 7)</li> <li>• Changing the Short Address</li> </ul>

	• Reading the unique identifier frame (test)
Maximum number of devices	15
Maximum number of variables read	25
Multidrop operating mode	Yes, up to 15 devices (multidrop)
Loop power supply	24 VDC (max 60 mA)
Analog reading of the 4-20mA line	No
Galvanic separation from the other circuits	250 VAC; 1500 VAC for 1 minute
Internal resistor	250 $\Omega$ , disabled by default <sup>(3)</sup>
<sup>(3)</sup> The resistor can be switched on/off in the data logger I/O settings menu. The resistor is automatically disconnected in the event of a power outage.	

<b>OUT6RL – relay outputs module</b>	
Number of outputs	6
Sensor type	Solid-state relays (SSR)
Maximum operating voltage/operating current	24 VAC / 0.5 A or 36 VDC / 0.5 A
The maximum voltage allowed	42 VAC or 60 VDC
Maximum peak current	1.5 A for 1 ms
Galvanic separation from the other circuits	250 VAC; 1500 VAC for 1 minute
Galvanic separation between channels	250 VAC; 1500 VAC for 1 minute

<b>OUT3 – analogue outputs module</b>	
Number of outputs (channels)	3
Specifications for current output	
Range (program selected)	4 - 20 mA 0 - 20 mA 0 - 24 mA
Output type	Active current source
Possibility of powering the current loop from an external voltage source	None
Resolution	12 bit / 0.006 mA
Accuracy ( $R_L=350 \Omega$ / $T_a=+25 \text{ }^\circ\text{C}$ )	< $\pm 0.15\%$ ( < $\pm 0.036 \text{ mA}$ ) full range of measurement (FSR)
Accuracy ( $R_L=350 \Omega$ / $T_a=-40 \dots +50 \text{ }^\circ\text{C}$ )	< $\pm 0.3\%$ ( < $\pm 0.072 \text{ mA}$ ) full range of measurement (FSR)
Load resistance $R_L$	0 $\Omega$ .. 500 $\Omega$
Maximum output voltage (for $R_L = \infty \Omega$ )	21.5 V
Specifications for voltage output	
Range (program selected)	0 - 5 VDC 0 - 10 VDC
Output type	DC voltage source
Resolution	12 bit (1.25 mV for 0 - 5 V) (2.5 mV for 0 - 10 V)
Accuracy ( $R_L=1 \text{ k}\Omega/C_L=200 \text{ pF}/T_a=+25 \text{ }^\circ\text{C}$ )	< $\pm 0.1\%$ full range of measurement (FSR) (Typically < $\pm 0,05\%$ FSR)
Accuracy ( $R_L=1 \text{ k}\Omega/C_L=200 \text{ pF}/T_a=-40 \dots +50 \text{ }^\circ\text{C}$ )	< $\pm 0.3\%$ full range of measurement (FSR)
The minimum load resistance $R_L$	1 k $\Omega$
The maximum load capacitance $C_L$	1 $\mu\text{F}$
Short-circuit protection	Yes
Specifications for current and voltage output	
Galvanic separation from other circuits	250 VAC; 1500 VAC for 1 minute
Galvanic separation between channels	250 VAC; 1500 VAC for 1 minute

<b>PSBATT – back-up battery module<sup>(4)</sup></b>	
Input voltage 24 VDC IN	24 VDC / 2 .. 2.5 A
BATT1, BATT2 (capacity)	NiMH 2x9.6 V / 1000 .. 6000 mAh (Typically 4600 NiMH or 2000 mAh)
BATT1, BATT2 temperature sensor	2x NTC 10 kΩ
Charging time	ca. 12 h (full charging)
<p><sup>(4)</sup> In the device, it is possible to install max 1 PSBATT module. From April 1, 2020, the PSBATT module is manufactured only in version 1.2. Version 1.2 of the module is not backward compatible. The Operating Manual contains information about the module's technical data in version 1.2. Technical details about the module in version 1.0 and in version 1.1 are available from the Manufacturer. Use only dedicated power supply.</p>	

<b>Table of RTD sensors</b>		
<b>Sensor type</b>	<b>Range</b>	<b>Accuracy</b>
Pt100, Pt200, Pt500, Pt1000 (EN 60751+A2:1995)	-200 °C .. +850 °C -328 °F .. +1562 °F	±0.5 °C (typically ±0.3 °C) ±0.9 °F (typically ±0.5 °F)
Ni100, Ni120, Ni1000 (DIN43760 /08-1985)	-60 °C .. +250 °C -76 °F .. +482 °F	±0.5 °C (typically ±0.3 °C) ±0.9 °F (typically ±0.5 °F)
Cu50, Cu53, Cu100 (GOST6651-2009)	-180 °C .. +200 °C -292 °F .. +392 °F	±0.5 °C (typically ±0.3 °C) ±0.9 °F (typically ±0.5 °F)
KTY81 (NXP Rev05-25.04.2008)	-55 °C .. +150 °C -67 °F .. +302 °F	±0.5 °C ±0.9 °F
KTY83 (NXP Rev06-4.04.2008)	-55 °C .. +175 °C -67 °F .. +347 °F	±0.5 °C ±0.9 °F
KTY84 (NXP Rev06-8.05.2008)	-40 °C .. +300 °C -40 °F .. +572 °F	±0.8 °C ±1.5 °F
Linear resistance	0 .. 4700 Ω (or sub-range)	±0.5 Ω (typically ±0.3 Ω)

<b>Table of thermocouples (TC)</b>		
<b>Sensor type</b>	<b>Range</b>	<b>Accuracy</b>
J (Fe-CuNi) (EN60584-1:1995)	-210 °C .. +1200 °C (compensation range -100 °C .. +300 °C) -346 °F ... +2192 °F (compensation range -148 °F .. +572 °F)	±1.0 °C (typically ±0.5 °C) ±1.8 °F (typically ±0.9 °F) (without compensation)
K (NiCr-NiAl) (EN60584-1:1995)	-270 °C .. + 1372 °C (compensation range -100 °C .. +300 °C) -454 °F .. +2501.6 °F (compensation range -148 °F .. +572 °F)	±1.0 °C (typically ±0.5 °C) ±1.8 °F (typically ±0.9 °F) (without compensation)
N (NiCrSi-NiSi) (EN60584-1:1995)	-270 °C .. +1300 °C (compensation range -100 °C .. +300 °C) -454 °F .. +2372 °F (compensation range -148 °F .. +572 °F)	±2.0 °C (typically ±1.0 °C) ±3.6 °F (typically ±1.8 °F) (without compensation)
R (PtRh 13-Pt) (EN60584-1:1995)	-50 °C .. +1768 °C (compensation range -50 °C .. +300 °C) -58 °F .. +3214.4 °F (compensation range -58 °F .. +572 °F)	±2.0 °C (typically ±1.0 °C) ±3.6 °F (typically ±1.8 °F) (without compensation)
S (PtRh 10-Pt) (EN60584-1:1995)	-50 °C .. +1768 °C (compensation range -50 °C .. +300 °C) -58 °F .. +3214.4 °F (compensation range -58 °F .. +572 °F)	±2.0 °C (typically ±1.0 °C) ±3.6 °F (typically ±1.8 °F) (without compensation)
T (Cu-CuNi) (EN60584-1:1995)	-200 °C .. +400 °C (compensation range -50 °C .. +300 °C)	±1.0 °C (typically ±0.5 °C)

	-328 °F .. +752 °F (compensation range -58 °F .. +572 °F)	±1.8 °F (typically ±0.9 °F) (without compensation)
E (NiCr-CuNi) (EN60584-1:1995)	-270 °C .. +1000 °C (compensation range -50 °C .. +300 °C) -454 °F .. +1832 °F (compensation range -58 °F .. +572 °F)	±1.0 °C (typically ±0.5 °C) ±1.8 °F (typically ±0.9 °F) (without compensation)
B (PtRh30-PtRh6) (EN60584-1:1995)	+250 °C .. +1820 °C (without compensation) +482 °F .. +3308 °F (without compensation)	±2.0 °C (typically ±1.0 °C) ±3.6 °F (typically ±1.8 °F) (without compensation)
L (Fe-CuNi) (DIN43710)	-200 °C .. +900 °C (compensation range -50 °C .. +300 °C) -328 °F .. +1652 °F (compensation range -58 °F .. +572 °F)	±1.0 °C (typically ±0.5 °C) ±1.8 °F (typically ±0.9 °F) (without compensation)
U (Cu-CuNi) (DIN43710)	-200 °C .. +600 °C (compensation range -50 °C .. +300 °C) -328 °F .. +1112 °F (compensation range -58 °F .. +572 °F)	±1.0 °C (typically ±0.5 °C) ±1.8 °F (typically ±0.9 °F) (without compensation)
Line voltage	-140 .. +140 mV (or sub-range)	<0.2% full range



---

**10 ENTITY LAUNCHING THE PRODUCT ON EUROPEAN UNION MARKET**

Manufacturer: METRONIC AKP sp. z o.o. sp. k.  
st. Żmujdzka 3  
PL 31- 426 Kraków, Poland  
Tel.: (+48) 12 312 16 80  
[www.metronic.pl](http://www.metronic.pl)

Vendor:



## 11 USER SCREENS

### 11.1 Information about the device

To show up information about the device select the button on menu bar.

This screen contains all the basic data concerning the device: model, ID, serial number, firmware, IP address, COM (RS485) communication parameters and Modbus address.

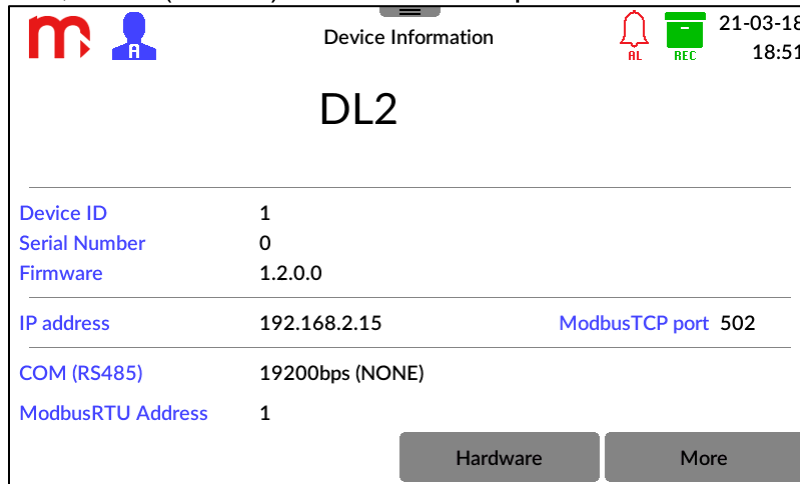
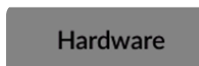
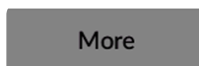

Fig. 11.1 An example view of the 'Device Information' window.

Additionally, this screen contains two function buttons:



Opens up the screen with the information about the currently installed measurement modules (the '-----' sign and the red color of the bar mean that no module is installed on the slot or the PSBATT module in version 1.0 or in version 1.1 is installed).



Opens up the window with additional information about the device, i.e. manufacturer's address, or contact details to technical support department. Additionally, for the user logged on as an Administrator, it is possible to edit this field and insert additional descriptions or information.

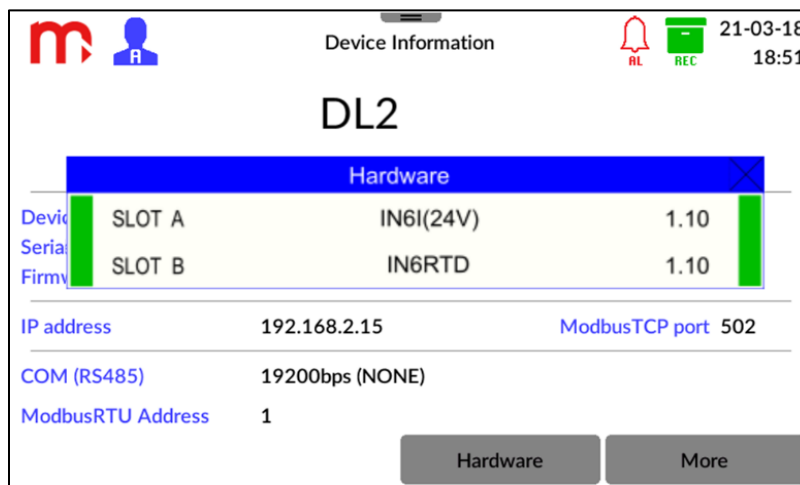



Fig. 11.2 An example view of the 'Hardware' window - Hardware configuration data window.

## 11.2 Results Tables

To display Results Tables window, select the  button on menu bar.

Depending on the number of defined tables, the window contains from 1 to 6 independent tabs. Each of them contains a table made up from up to 15 fields in the 3x5 layout.

Each fields (depending on the settings) enables the display of:

- description,
- current value,
- totalizers values,
- maximum or minimum,
- a unit for the selected measurement channel.

Clicking on the relevant table field, toggles the user to the window - [Single result window](#) of a selected channel.

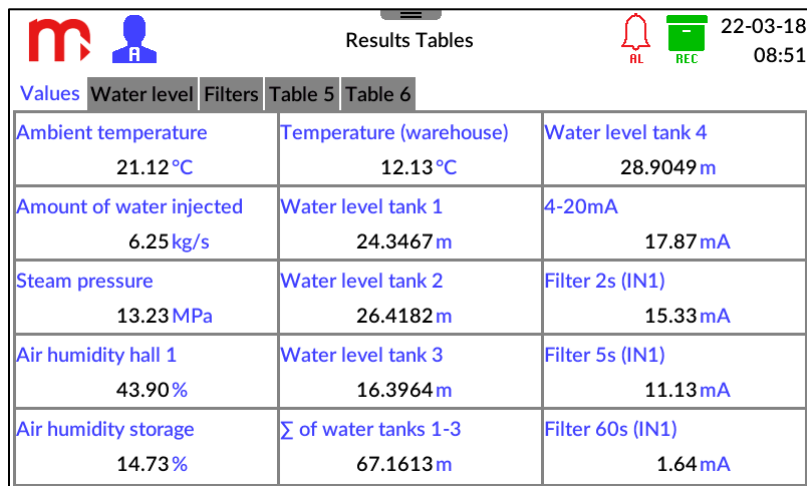

Results Tables		
Values	Water level	Filters
Ambient temperature 21.12°C	Temperature (warehouse) 12.13°C	Water level tank 4 28.9049 m
Amount of water injected 6.25 kg/s	Water level tank 1 24.3467 m	4-20mA 17.87 mA
Steam pressure 13.23 MPa	Water level tank 2 26.4182 m	Filter 2s (IN1) 15.33 mA
Air humidity hall 1 43.90%	Water level tank 3 16.3964 m	Filter 5s (IN1) 11.13 mA
Air humidity storage 14.73%	Σ of water tanks 1-3 67.1613 m	Filter 60s (IN1) 1.64 mA

Fig. 11.3 An example view of the 'Results Tables' window.

## 11.3 Trends

To display Trends window, select the  button on menu bar.

Depending on the number of defined trends, the window contains from 1 to 6 independent tabs. Each tab contains the trend field, enabling the display of up to 6 lines and the legend field containing information on the displayed values (channel description, current value and unit). To facilitate identification, each of the descriptions has a different colour, corresponding to the line on the graph.

The user can switch the legend on and off by clicking the graph field. During the toggling between the individual tabs the legend display mode is not changed. The Trends window displays the values from the last hour (changing the view using the bar under the graph). Trends display 400 s (with the legend switched off) or 260 s (with the legend switched on).

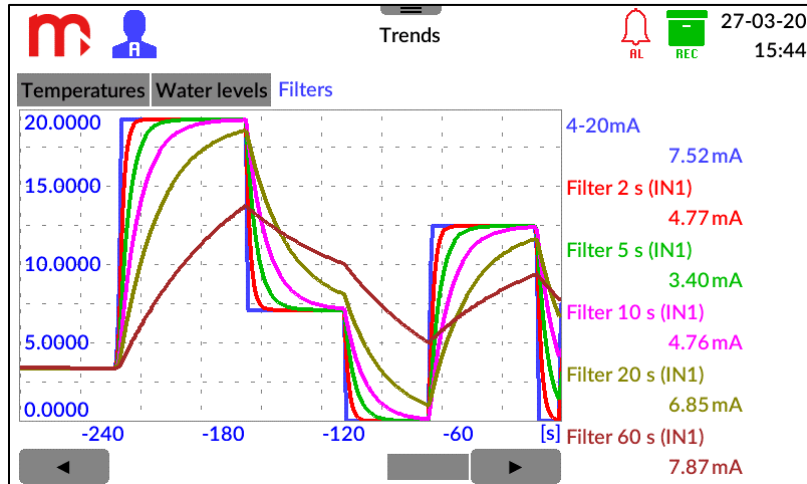

Fig. 11.4 An example view of the 'Trends' window.

Channel descriptions are also function buttons. Clicking on a selected description, toggles to a suitable **Single result window**.

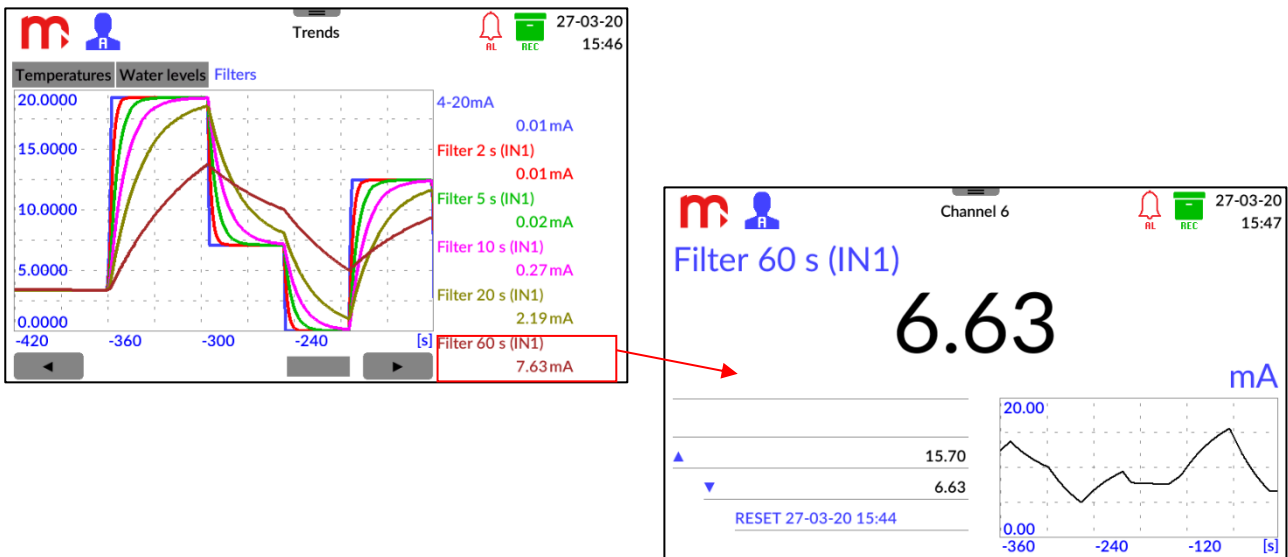

Fig. 11.5 Toggling from the 'Trends' window to a Single Result window.

### 11.4 Single result window

The window is used for displaying a single result channel (only for enabled channels).

The window displays all data concerning a selected measurement channel:

- channel description,
- current value,
- a unit,
- values of totalizers 1 and 2 (if totalizers are active),
- units of totalizers 1 and 2 (if totalizers are active),
- min and max values (based on current value),
- trend of values from the last 400 s,
- trend of values from last hour (after maximizing the chart), changing the view using the bar under the chart.

In the top part of the screen, there is a channel description entered by the user. Below, the current value measured by the channel is displayed together with the unit declared by the user. The bottom part of the screen is additionally sub-divided into two parts. The left part displays the totalizers values with the units and the minimum and maximum values.

Clicking on the totalizers field enables zeroing the totalizers marked as resettable and resting the maximum and minimum values. It is possible to delete auxiliary values for a single channel or for all active channels ( $\Sigma 1, \Sigma 2$ , the max. and min. values). The right part of the screen contains a trend graph from the last 400 s. Clicking the trend area results in maximisation of the graph. To restore the previous view, press again on the graph field. After maximizing the chart, the trend line value of the channel for the last hour is displayed (changing the view using the bar under the chart).

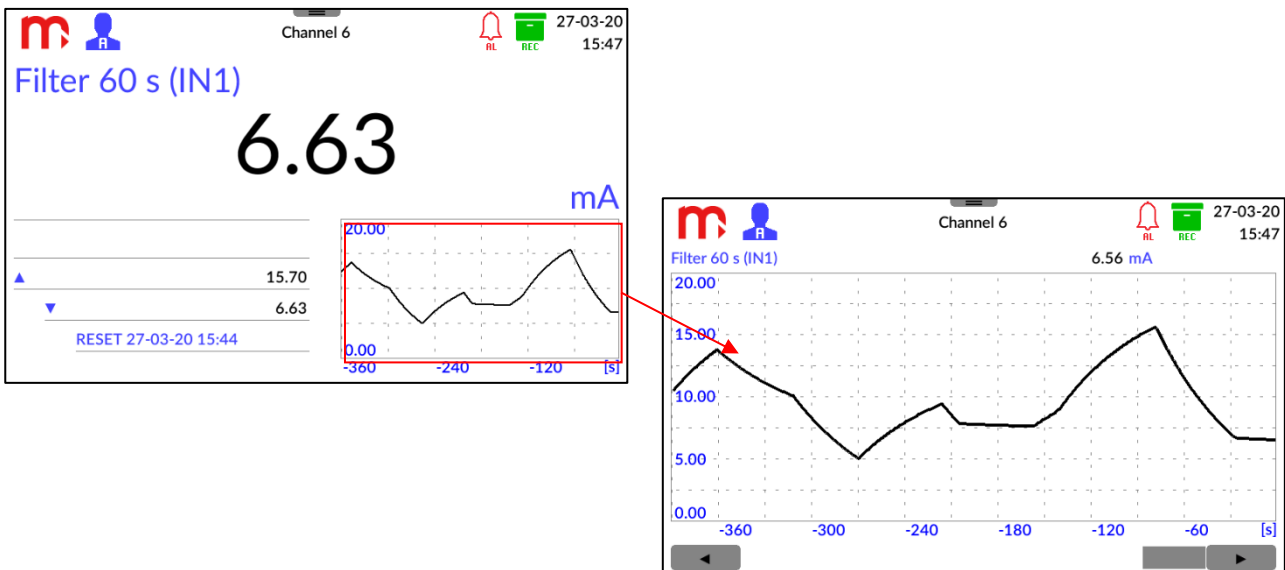

Fig. 11.6 Clicking on the trend area in the Single result window displays the graph in full screen mode.

Using the arrows from the menu bar, a change of the displayed channels is possible. Keeping the buttons down for a few seconds enables automatic displaying other channels.

## 11.5 Archive

To display Archive window, select the  button on menu bar.

Archive window is sub-divided into two parts. Above is the field containing information about the frequency of the archiving data. There is also information about number and type current archives. For the current data archive, two archiving frequencies have been envisaged. The active one is marked in black (inactive is marked in grey). In this field there is an information about the frequency of the archiving totalizers. Additionally, this field contains information concerning the percentage use of the internal memory of the devices.

Below, two tabs corresponding to the archive of current values and totalizers are displayed. In the *Process Values* tab, one square corresponds to a single channel (current value). In the *Totalizers* tab, the upper square corresponds to the first totalizer and the bottom one to the other totalizer. The value stored in the archive is marked in green (not archived value is marked in grey).

This window also contains functional buttons for the control of the archiving process (STOP/START and New Archive), available for logged-in user. Details of these operations are given in section [ARCHIVE](#).

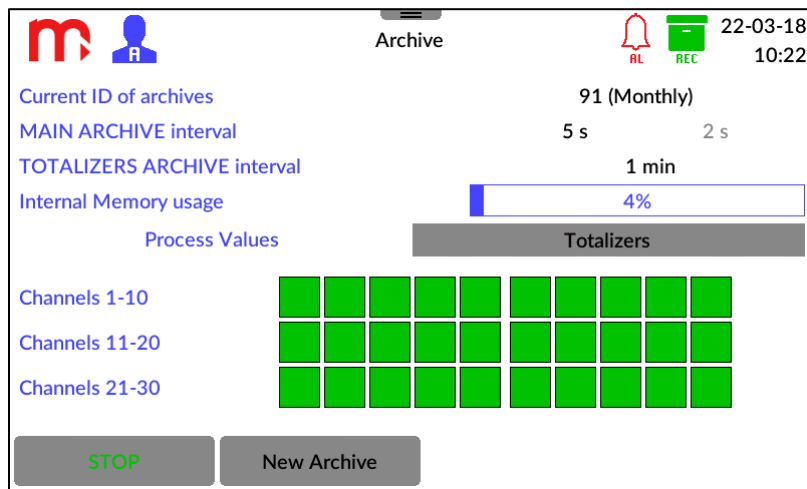

Fig. 11.7 An example view of the 'Archive' window.

## 11.6 Main Menu

To display Main Menu window, select the button on menu bar.

This screen contains a menu made up from the function icons and their descriptions. Clicking on the pictogram toggles the user to a suitable sub-screen with settings windows: Login, General, I/O, Communication, Channels, Screens, Archive, USB. More information in section [PROGRAMMING SETTINGS](#).

Switching to individual settings windows is possible only for the for logged-in user. The settings can be saved from the Administrator level.

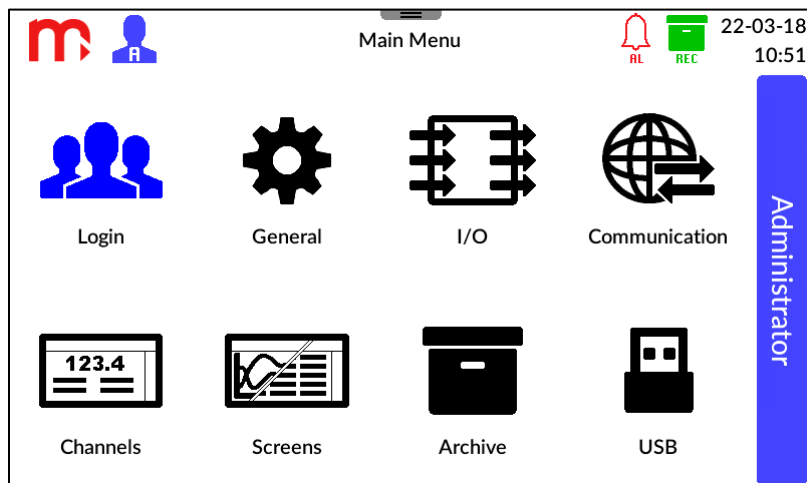

Fig. 11.8 An example view of the 'Main Menu' window.

**!** Using the Main Menu screen any changes to the device settings can be done. Having made and accepted the changes, click on any icon from the menu bar (other than the Main Menu icon). It will be displayed a message requesting you to confirm the changes. Having approved them, in some cases, the device will switch off and reboot with the new settings.

### 11.7 Alarms

To display Alarms window, select the button on menu bar or the icon on title bar.

This screen contains alarm statuses for all channels. For each of the channels is assigned a single rectangle divided into two parts corresponding to the first and second alarm respectively.

Identification of alarms is possible by to the appropriate colors:

- alarm disabled
- alarm enabled, inactive
- alarm enabled, active

If the alarm color is not declared (selected from the list during configuring alarms settings as *Disabled*), it will be marked in blue when an alarm occurs.

If the displayed color (red, green, orange, blue) flashes, then the alarm is unacknowledged. Continuous displaying of the color means confirmed alarm.

Depending on the settings, the device may make a sound signal for new alarms.

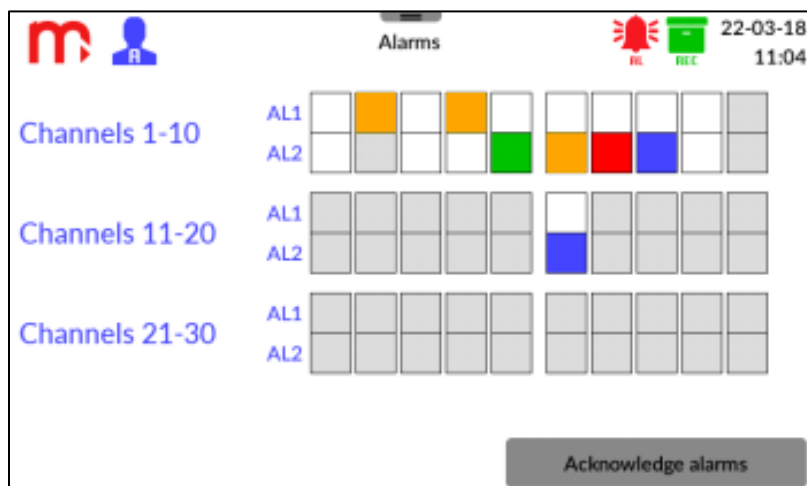
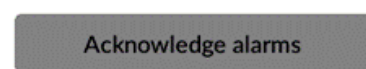

Fig. 11.9 An example view of the 'Alarms' window.

Confirmation of alarms is done by pressing the button (required access level: User or higher).



## 12 PROGRAMMING SETTINGS

**!** To accept any changes to the device setting, first confirm them using the button in the right bottom part of the screen, and then click any icon on the menu bar (other than the Main Menu icon). It will be displayed a message requesting you to confirm the changes. After confirmation, in some cases, the device will switch off and reboot with the new settings.

Clicking the button will close a particular window and cancel any changes that were done.

Changing the settings starts in the [Main Menu](#) window (button on menu bar). Clicking on the icon toggles the user to a suitable sub-screen with settings windows:

- [Login](#),
- [General settings](#),
- [Input and output settings](#),
- [Communication settings](#),
- [Channels settings](#),
- [Screens setting](#),
- [Archive settings](#),
- [USB](#).

### 12.1 General settings

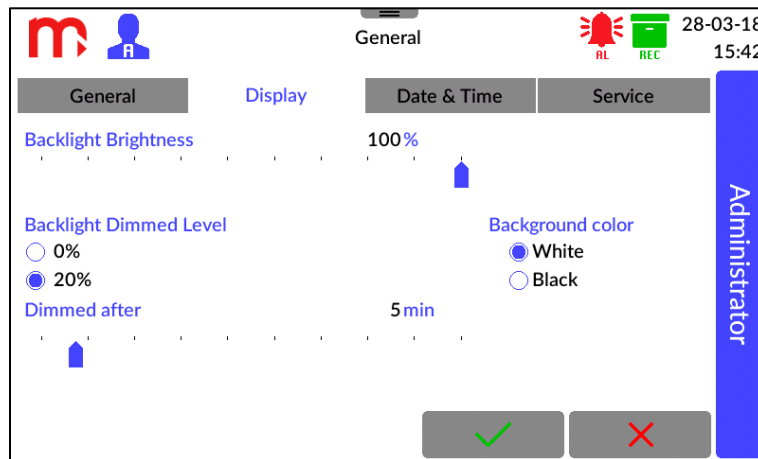

Fig. 12.1 An example view of the 'General' settings window – 'Display' tab.

#### 12.1.1 General

Language: **EN (ENGLISH)** (EN (ENGLISH), DE (DEUTSCH), ES (ESPAÑOL), FR (FRANÇAIS), IT (ITALIANO), PL (POLSKI), PT (PORTUGUÊS))<sup>[1]</sup>

Device Tag: [text]<sup>[2]</sup>

Device ID: 1<sup>[3]</sup>

**Sound for buttons: Enabled** (Disabled, Enabled)<sup>[4]</sup>

**Sound for new alarms: Enabled** (Disabled, Enabled)<sup>[5]</sup>

**Changing DST: Enabled** (Disabled, Enabled)<sup>[6]</sup>

[1]: Selection from the drop down list.

[2]: Enables to insert any description (name) of the device.

[3]: Device ID enables to assign an individual ID number. The ID is also included in archive files names.



**When using more recorders it is recommended to assign individual ID to each one. It will allow to recognize the archive source by ID in the file name.**

[4]: Turns on/off the button sound.

[5]: Turns on/off the sound for new alarms.

[6]: Turns on/off the automatic change of time into the summer time and back.

### 12.1.2 Display

**Backlight Brightness**<sup>[1]</sup>

**Backlight Dimmed Level: 20%** (0%, 20%)<sup>[2]</sup>

**Background color** (white, black)<sup>[3]</sup>

**Dimmed after**<sup>[4]</sup>

[1]: Setting screen brightness level during the operation from 21 to 100% (using slider).

[2]: Selection of the screen saver brightness level after the define idle time. User can choose two screen saver levels: 0% (the screen goes black) and 20%.

[3]: Setting the background color of the screen, two colors to choose from: white and black.

[4]: Setting the idle time after the elapse of which the screen goes dimmed (using slider); for *0 min* - the screen will not be dimmed.

### 12.1.3 Date & Time

**Time field**

Enables the setting of time in the hour/minute/second format. The changes are made using the three sliders. The current parameters are marked in red. After the change of settings, confirm the selected options by clicking on the **SET** button (below).

**Date field**

Enables setting the date in the day/month/year format. Setting the date is enabled by using the 'calendar card'. Using the arrows in the top part of the field, set the relevant month and year, and then in the field below, the day of month, which after selecting will be marked with a rectangle filled with blue color. The current date is marked in a blue frame. After the change of settings, confirm the selected options by clicking on the **SET** button (below).



**After the confirmation of changes, the data will be changed immediately without rebooting the device.**



### 12.1.4 Service

The maintenance tab is only available to the Administrator and enables execute following tasks:

- **Reset** – results in restart of the device.
- **Restore Factory Settings** – using the function will result in deleting all of the earlier settings, the archive files created so far will not be deleted (more in section [Factory settings](#)).
- **Serial number and MAC address** – enables displaying the serial number and MAC address.
- **Configuration of HART cards** – enables configuration of installed HART cards. After selecting a card from the list and pressing the *Configure card* button, the configuration window of transmitters connected to the card appears.

**Notes:** There is a *Resistor 250 Ω* field in the window, used for service setting on/off of the resistor. After opening the window, the resistor status complies with the saved (currently used) settings in the I/O window. Turning on the resistor may be necessary to power the sensors. Before switching on the resistor, used electrical connection should be taken into account. After closing the window, the resistor status will be restored to the saved settings.

In the window, enter the short address of the device (0-15) and press the *Get a long address* button. The long address is necessary during reading the values of variables from devices in rev 5, in rev 6 and in rev 7. The test frame read for the variable PV is displayed below. In the window it is possible to change the short address of the device: enter the short address and communicate with the device (*Get a long address*), then in the *Change the short address to* field enter a number from the range 0-15 and press the *Change* button.

## 12.2 Input and output settings

The window enables configuration of connected measurement cards. From the drop down list (in the upper left corner) select the number of the measurement card slot.

Having selected a suitable measurement card slot from the list, it is possible to program the individual inputs and outputs of the module. Selecting a suitable item from the list, the type of installed card will be displayed. User can use six tabs, each of which corresponds to the consecutive input/output. The user can define the operating mode for each input (regardless of the other inputs).

If there is no installed card (module) or the PSBATT module in version 1.0 or in version 1.1 is installed, the "-----" symbol will be displayed.

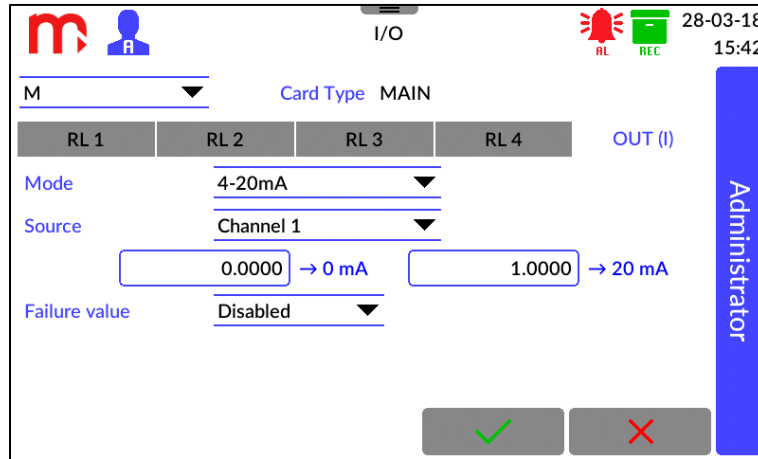

Fig. 12.2 An example view of the 'Inputs and Outputs' settings window – 'OUT (I)' tab.

### 12.2.1 Module M (MAIN)

#### RL1-RL4 tabs

**Mode: Disabled** (Disabled, Normally open, Normally closed, Pulsation)<sup>[1]</sup>

- [1]: Selection the relay operation modes as: *Disabled, Normally open, Normally closed* or *Pulsation*.

**Notes:** Regardless of the *Mode* selected, after switching off the device and during starting the device, the relay outputs remain open.

#### OUT (I) tab

**Mode: Disabled** (Disabled, 4-20mA)<sup>[1]</sup>

- [1]: Selection the output mode as switched off or as a retransmission of the selected channel value in the form of 4-20mA current loop.

4-20 mA span may be set as a sub-range of retransmitted channel span by entering the process values for 4 mA and 20 mA respectively.

**Source: Channel 1** (Channel 1 – Channel 30)<sup>[2]</sup>

**Failure value: Disabled** (Disabled, Constant)<sup>[3]</sup>

- [2]: Selection one of the channels (selection of any channel from 1 to 30), which value will be retransmitted as 4-20mA current loop signal.  
 [3]: Setting the failure value.

### 12.2.2 Programming options for the individual modules

- **IN6I / IN6I(24V)**

**Mode: Disabled** (Disabled, 0-20mA, 4-20mA)<sup>[1]</sup>

**Adjustment:** [value] mA<sup>[2]</sup>

- [1]: It enables setting the range of the current loop 0-20 mA or 4-20 mA signal.  
 [2]: It enables to add adjustment (offset) to the measured current value.

Other module parameters are configured in the Channels tab.

To the mA current value, the physical value is assigned (linear or custom defined characteristic).

- **IN6T**

**Mode: Disabled** (Disabled, 2-wires, 3-wires, 4-wires, TC)<sup>[1]</sup>

**Adjustment:** [value]  $\Omega$  and [value] mV<sup>[2]</sup>

**Compensation:** Disabled (Disabled, Constant, Channel 1, ..., 100)<sup>[3]</sup>

- [1]: RTD sensors can be connected in a three-wire or four-wire configuration with automatic cables resistance compensation or a two-wire configuration without compensation.
- [2]: Resistance correction allows the cable resistance values to be entered manually in the two-wire configuration. If the sensor is connected in a three-wire or four-wire configuration (automatic compensation), the resistance correction can be used to compensate the sensor error by “offsetting” the characteristics by adding the positive or negative resistance value.
- [3]: The compensation method of thermocouple reference junction (cold junction compensation). Compensation can be provided by another measurement channel. In particular, a fixed value can be selected for compensation. However, this type of measurement is likely to be incorrect. As a rule, Pt100 sensor connected to the different measurement channel is used as a compensation sensor or the internal sensor is used. During the programming of the compensation settings, attention to use the same temperature units °C or °F for both measured and compensation channels should be paid.

Other module parameters are configured in the Channels tab.

To the resistance value in  $\Omega$ , the selected sensor (eg. Pt100) or the physical value (linear or custom characteristic) is assigned.

- **IN6V**

**Mode: Disabled** (Disabled, -10-+10V, 0-10V)<sup>[1]</sup>

**Adjustment:** [value] V<sup>[2]</sup>

- [1]: Working mode depends on the type of the connected transducers.
- [2]: It enables to add adjustment (offset) to the measured voltage value.

Other module parameters are configured in the Channels tab.

To the voltage value in V, the physical value (linear or custom characteristic) is assigned.

- **IN6**

**Mode: Disabled** (Disabled, RTD 2 wires, RTD 3 wires, RTD 4 wires, TC, 0-20mA, 4-20mA, -10-+10V, 0-10V)<sup>[1]</sup>

**Adjustment:** [value]<sup>[2]</sup>

**Compensation:** Disabled (Disabled, Constant, Channel 1, ..., 100)<sup>[3]</sup>

- [1]: Working mode depends on the type of the connected measuring sensor.
- [2]: It enables to add adjustment (offset) to the measured value.
- [3]: The compensation method of thermocouple reference junction (cold junction compensation). Compensation can be provided by another measurement channel. In

particular, a fixed value can be selected for compensation. However, this type of measurement is likely to be incorrect. As a rule, Pt100 sensor connected to the last measurement channel is used as a compensation sensor or the internal sensor is used. During the programming of the compensation settings, attention to use the same temperature units °C or °F for both measured and compensation channels should be paid.

- **IN4SG**

**General:** Averaging Filter (Disabled, Enabled)<sup>[1]</sup>,  
TARE mode (Independent, Logical sum)<sup>[2]</sup>,

**IOx:** Mode (Disabled, Enabled)<sup>[3]</sup>,  
Adjustment ( [mV] )<sup>[4]</sup>

[1]: 10 latest measurements running average,

[2]: individual or simultaneous channels reset (tare),

[3]: channel activation on/off,

[4]: It enables to add adjustment (offset) to the measured voltage value.

Other module parameters are configured in the Channels tab.

The card has four analog measurement channels for direct strain gauges connecting. But to the user there are six channels available. The fifth channel is the sum of all active measurement channels. The sixth channel indicates the state of the tare input and is of a service nature.

By multiplying the sensitivity of the strain gauge [mV / V] by 5V (strain gauge supply voltage from the module), the range voltage in [mV] corresponding to the load capacity of the sensor [kG] or [kN] range is obtained.

- **IN3D**

**Mode:** Disabled (Disabled, State, Frequency, Impulse counter)<sup>[1]</sup>

**Type:** Voltage (Voltage, OC, E+H, NAMUR)<sup>[2]</sup>

**Filter:** Disabled (Disabled, Enabled)<sup>[3]</sup>

[1]: Depending on the configuration, the inputs can operate in state on-off detection, frequency measurement or pulse counting mode.

[2]: Hardware type of transducer connected: with Voltage output, with OC (open-collector or contact) output, E+H (current type) output, NAMUR type output.

[3]: For low-frequency signals, in particular signals coming from mechanical contact, it is possible to activate an additional low-pass filter at ca. 100 to 300 Hz cut-off frequency.

- **IN6D**

**Mode: Disabled** (Disabled, State, Frequency, Impulse)<sup>[1]</sup>

**Debounce: Disabled** (Disabled, 1 ms, 3 ms)<sup>[2]</sup>

[1]: Depending on the configuration the module, binary inputs can work as a state detector, a pulses counter or a frequency meter.

[2]: For low frequency signals, in particular for the contact type transmitters, an additional debounce filter can be activated with a time jumper to approx. 1 ms or 3 ms.

Other module parameters are configured in the Channels tab.

To the frequency value in Hz, the physical value (linear or custom characteristic) is assigned.

- **2RS485(24V) / 2RS485**

**RS485 COM** tab

This tab enables configuration of all settings related to the communication of the device after the RS485 digital bus with other devices.

**Baud Rate: 19200** (Disabled, 1200, 2400, 4800, 9600, 19200, 38400, 57600, 115200)<sup>[1]</sup>

**Parity: NONE** (ODD, EVEN, NONE)<sup>[2]</sup>

**Stop Bits: 1b** (1b, 2b)

**Timeout:** [value] ms<sup>[3]</sup>

[1]: Baud Rate should be set to the highest possible value. For high distances or high interference level, data transmission speed may need to be decreased. Low transmission speed extends the reading time.

[2]: Parity control of each bite.

[3]: Timeout between Query and Response.

**Register** tab

**IO**<sup>[1]</sup>

**Port: Disabled** (Disabled, 1, 2)<sup>[2]</sup>

**Device:** [device address]<sup>[3]</sup>

**Address:** [value]<sup>[4]</sup>

**Type: uint(16bit)** (uint (16bit), int (16bit), uint (32bit), uint (32bit) sw, int (32bit), int (32bit) sw, float (32bit), float (32bit) sw, int (64bit), double (64bit))<sup>[5]</sup>

[1]: Module's measurement channel number. Each of the modules provides 25 measuring channels, the numbering of which allows for easily assigning the appropriate measurement to the display channel.

[2]: The number of the module port used. Each module has two active ports.

[3]: Slave device address from which the data will be read.

[4]: Set the register's number from which data will be read. Available format: 3xxxx / 3xxxxx or 4xxxx / 4xxxxx, where: 3 – input registers, 4 – holding register and xxxx / xxxxx – four / five digit address. To speed up the communication, set consecutive register's numbers in increasing order. The value must be given in decimal system (see section [MODBUS RTU / MODBUS TCP TRANSMISSION PROTOCOL](#)).

**Notes:** It is possible to group registers, which speeds up the data transmission. If the order of addresses for consecutive registers is retained for one device and the value in the field Type<sup>[5]</sup> is chosen so that the sums of the values of the Address and Type are consecutive numbers, then one Query can obtain a value for several consecutive registers within one communication frame.

[5]: 10 formats of readings are available in the drop-down list, where: uint – unsigned integer, int – signed integer, float – single precision floating point, double – double precision floating point, sw – swapped format (more information in section [Data types](#)). Choose a format that matches the specification of the sensor or device you are reading.

Other module parameters are configured in the Channels tab.

- **1HRT**

**General tab**

The tab enables configuration of basic settings related to the data logger communication with other devices in the HART standard.

**Master: Primary** (Primary, Secondary)<sup>[1]</sup>

**Resistor 250 Ω: Disabled** (Disabled, Enabled)<sup>[2]</sup>

**Preamble:** [value] B<sup>[3]</sup>

- [1]: The device can be configured as a *Primary Master* or as a *Secondary Master*.
- [2]: The internal 250 Ω resistor is *Disabled* by default. The resistor is turned on with using settings in the General tab. The internal resistor is automatically disconnected in case of power failure to the device. If there is a need to maintain the loop current in the event of a power failure, an external resistor R250 Ω should be used.
- [3]: Enter number of the preamble bytes (5 B by default).

**Field devices tab**

The tab enables defining devices connected to the data logger. In the case of devices in rev 5, in rev 6 and in rev 7 it is necessary to use the long device address (obtain a long address in the General window, in the [Service](#) tab).

**Mode: Disabled** (Disabled, Enabled)<sup>[1]</sup>

**Address:** [device address]<sup>[2]</sup>

- [1]: Set the *Enabled* mode for the connected device. If the transmitter or device connected with the data logger is disconnected, it is recommended to turn off the device (changing the settings of [Channels](#) and *Variables* tab is not required); after reconnecting the sensor, turn on the device.
- [2]: Address of the transmitter or device from which the measurement results are to be read. For a device in rev 4, enter the short address (in the range 0-15 DEC), for a device in rev 5, rev 6 and rev 7, enter the long address of the device (HEX).

**Variables tab**

The tab enables defining variables read by the data logger.

#<sup>[1]</sup>

**Field device: Disabled** (Disabled, selection from the list of added devices)<sup>[2]</sup>

**Type: PV** (PV, SV, TV, FV, DVC)<sup>[3]</sup>

**Code: --** (--, value)<sup>[4]</sup>

**Command: 03** (01, 03, 09)<sup>[5]</sup>

**Status: Enabled** (Disabled, Enabled)<sup>[6]</sup>

- [1]: Module measuring channel number. Each module provides 25 measurement channels, the numbering of which enables easy assigning an appropriate measurement to a given displayed [channel](#).
- [2]: Selection from the list of added devices (configuration in the *Field devices* tab). It is possible to assign a device in the *Disabled* mode to the variable.
- [3]: Type of the read variable.

- [4]: For the DVC variable, the code of the read variable must be given.
- [5]: The command used to read the variable. The command 01 and 03 can be selected for the PV variable. The SV, TV and FV variables have the 03 command defined, the DVC variable has the 09 command defined.

**Note:** The card enables grouping registers, which speeds up data transmission. If the command 03 was selected for several variables read from one device, then during one query the value for the variables PV, TV, SV and FV is got.

- [6]: Enabling or disabling the status analysis in the read HART frame. The *Enabled* status will result in displaying the variable value in case of correct HART status and displaying the --ERR-- symbol in case of incorrect HART status (the variable value is not displayed). The *Disabled* status will cause display variable value also in the case of an error status received in the HART frame (the information on the incorrect status is ignore). For DVC the status is always disabled. Detailed description of failure statuses in the [Failure symbols for 1HRT module](#) section.

Other module parameters are configured in the Channels tab.

- **OUT6RL**

**Mode: Disabled** (Disabled, Normally open, Normally closed, Pulsation)<sup>[1]</sup>

- [1]: In the *Normally open* mode the relay circuit is closed when an event is reported (e.g. exceeded alarm-control threshold). In the *Normally closed* mode, the relay circuit is normally closed when idle, and is opened when an event is reported. *Pulsation* - when an event is reported, the relay circuit is closed and opened at approx. 1Hz frequency (e.g. a light indicator blinks - alarm notification). After the acknowledge, the relay output remains active if the threshold is still exceeded (the indicator is lit). If the exceeding returns to normal – the relay output will be inactive.

**Note:** Regardless of the *Mode* selected, after switching off the device and during starting the device, the relay outputs remain open.

- **OUT3**

**Mode: 0-20mA** (Disabled, 0-20mA, 4-20mA, 0-24mA, 0-5V, 0-10V)<sup>[1]</sup>

**Source: Channel 1** (Channel 1-30)<sup>[2]</sup>

**Failure value: Constant** (Disabled, Constant)<sup>[3]</sup>

- [1]: Setting the operating mode of a given output to generate standard loop current signals: 0-20 mA, 4-20 mA, 0-24 mA or standard voltage signals: 0-5 V, 0-10 V, (*Disabled* sets the output to 0-5 V mode and value 0 V).
- [2]: Selection of the channel which value is to be retransmitted. The output span may be set as a sub-range of retransmitted channel span by entering the process values for minimum and maximum span value respectively.
- [3]: The failure from the source channel may be retransmitted as the constant “special” value on the output. If *Disabled* mode is selected, the value is set to 0, except for to mode 4-20mA when it is set to 3.6 mA.

Other module parameters are configured in the Channels tab.

- **PSBATT**





In the I/O settings window additional module configuration is not required. The module operating parameters are automatically assigned to subsequent virtual measuring inputs:

1. Battery charge status {1; 2; 3}:
  - 1 – low battery level
  - 2 – medium battery level
  - 3 – high battery level
- Notes:** The approximate battery charge indicator depends on the load.
2. Operating mode: charging / discharging {0; 1; 2; 3}:
  - 0 – battery operating (external power supply switched off)
  - 1 – pre-charging
  - 2 – main charging
  - 3 – recharging
3. Voltage (BATT1+BATT2) [V] (approximate value, accuracy  $\pm 5\%$ )
4. Charging current [A]
5. BATT1 battery temperature [°C]
6. BATT2 battery temperature [°C]

To display parameters, they must be assigned to selected channels in the [Channels settings](#) window. After choosing the slot (A, B), choose the input corresponding to one of the parameters listed above.

### 12.3 Communication settings

The window is divided into four sub-windows: Ethernet parameter settings, settings for sending E-mails, settings for Modbus TCP communication and settings for RS-485 communication (switching using tabs).

Confirm  and cancel  buttons are common for all sub-windows, clicking on these buttons results in toggles to the Main Menu.

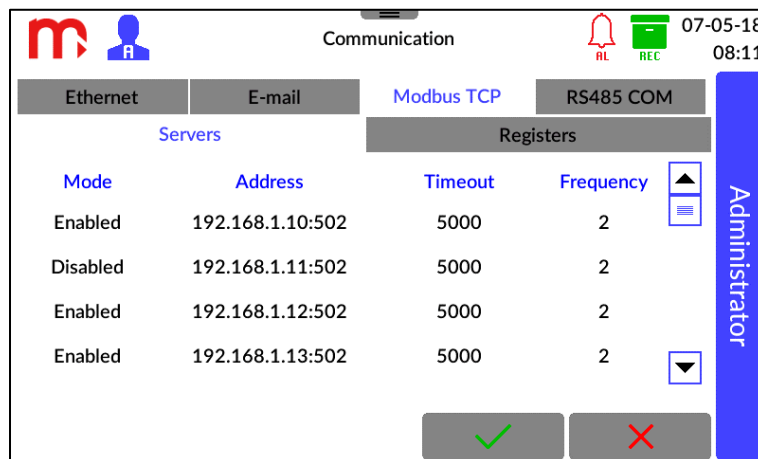

Fig. 12.3 An example view of the 'Communication' settings window.

#### 12.3.1 Ethernet port

To ensure proper communication between the device and the master system, all communication parameters need to be configured.



**IP address:** [value]<sup>[1]</sup>

**ModbusTCP port:** [value]<sup>[2]</sup>

**Mask:** [value]<sup>[1]</sup>

**Gate:** [value]<sup>[1]</sup>

**Primary DNS:** [value]<sup>[3]</sup>

**Secondary DNS:** [value]<sup>[3]</sup>

- [1]: These parameters should correspond to the network where the recorder is intended to operate.
- [2]: It is recommended to use the 502 port dedicated to Modbus TCP, port 80 is not allowed (reserved for the device's www server).
- [3]: A DNS address is necessary to use the e-mail function. Default DNS server settings: primary address 8.8.8.8, secondary address 8.8.4.4.

### 12.3.2 E-mail

The device can send automatic e-mails regarding alarm statuses and totalizers values. Before configuring the *E-mail* tab, configure the *Ethernet* tab and save the settings changes (exit the menu, the device will be restarted). The device must be connected to the network.

A message regarding alarm states is sent after exceeding at least one alarm threshold and after returning to the normal value (it is necessary to select the *E-mail Notification* option in the *Alarm 1 / Alarm 2* tab, more in section [Channels settings](#)). If several alarm thresholds have been exceeded or the value has returned to normal at several channels, the device will send common information about these alarms. Subject of the e-mail: DL2, ALARM, device ID, device tag.

The message regarding the totalizers values is sent in accordance with the settings in the *Cyclic report* tab (it is necessary to select the *E-mail Notification* option in the  $\Sigma 1 / \Sigma 2$  tab, more in section [Channels settings](#)). Subject of the e-mail: DL2, RP, device ID, device tag.

#### General tab

Enter information about the email account from which messages will be sent. Account outgoing server (SMTP) must be enabled. The maximum number of messages sent by email account per day should be taken into account.

**E-mail:** [value]<sup>[1]</sup>

**Login:** [value]<sup>[2]</sup>

**Password:** [value]<sup>[3]</sup>

**SMTP server:** [value]<sup>[4]</sup>

**SSL (TLSV1.2):** (Disabled, Enabled) <sup>[5]</sup>

**SMTP port:** [value]<sup>[6]</sup>

- [1]: The full address of the email account from which messages will be sent.
- [2]: The login used on the server to log into the e-mail account.
- [3]: The password used on the server to log into the e-mail account.
- [4]: The SMTP server address where the e-mail account is created.
- [5]: Enable/disable email encryption.

[6]: The SMTP server port (without SSL) should be verified at the e-mail provider (ports 587 or 25 are used as default) , (with SSL) port 465.

### Recipients tab

Enter the e-mail addresses of message recipients into the table. The sender of the message (*General* tab) can be also the recipient of the message.

**#:** 1 (1, ..., 5)<sup>[1]</sup>

**E-mail:** [value]<sup>[2]</sup>

[1]: Ordinal number from 1 to 5, the message can be sent to a maximum of 5 recipients.

[2]: The full e-mail address of the recipient to which the messages will be sent.

It is recommended to check the correctness of the connection configuration using the **Test connection** button located below the table. Message about the connection is displayed, color indicates the status of the connection: green – message sent correctly to defined recipients, yellow – authorization error (check the correctness of entered data in the *General* tab and in the *Recipients* tab), red – connection error (check the Ethernet cable, network connection and settings of the IP address, mask and gate in the *Ethernet* tab).

The test message sent to the entered e-mail addresses contains the model, firmware, serial number, device ID and tag of the device. Subject of the e-mail: DL2, TEST, device ID, device tag.

### Cyclic report tab

The cyclic report contains the values and units of the selected totalizers at the time of sending the message.

**Mode: Disabled** (Disabled, Daily, Weekly, Monthly)<sup>[1]</sup>

**Hour: 0** (0, ..., 23)<sup>[2]</sup>

[1]: E-mail messages can be sent in the mode: *Daily* – select *Hour*, *Weekly* – select *Hour* and *Day of the week* or *Monthly* – select *Hour* and *Day of the month* of sending the message. The e-mail will be sent at the indicated time and will contain the values and units of the totalizers at the time of sending the message (data sent in the form of a table).

[2]: The e-mail is sent at the indicated full hour or each time after starting the device within the indicated hour. In case of unsuccessful connection to the server, there are three more attempts to send the report at intervals of 5 minutes each.

### 12.3.3 Modbus TCP (Client)

Device enables reading out up to 30 values from 20 devices via Ethernet connection (Modbus TCP protocol). To ensure proper communication, all parameters in *Servers* tab and in *Register* tab need to be configured.

Read values can be assigned to channels (channel type: *Modbus TCP*, more information in section [Channels settings](#)).

### Servers tab

Up to 20 servers can be configured.

**Mode: Disabled** (Disabled, Enabled)<sup>[1]</sup>

**Address:**<sup>[2]</sup> **IP address:** [value]<sup>[3]</sup>  
**Port:** [value]<sup>[4]</sup>

**Timeout:** [value] ms (1000, ..., 60000)<sup>[5]</sup>

**Frequency:** [value] s (1, ..., 3600)<sup>[6]</sup>

- [1]: Turns on/off servers. If sensor or device (*slave*) connected with servers will be disconnected, it is recommended to set mode for server as *Disabled* (changed in *Channels* window and in *Register* tab is not necessary); after plugged on sensor set mode for server as *Enabled*.
- [2]: Column *Address* enabling easy identification of the added server. Entered data are displayed in the format *IP address:Port*, for example 192.168.2.15:502.
- [3]: Parameters should correspond to the network where the recorder is intended to operate.
- [4]: It is recommended to use the 502 port dedicated to Modbus TCP, port 80 is not allowed (reserved for the device's www server).
- [5]: Timeout between Query and Response.
- [6]: Frequency of Query sending. If several sensors are connected to one server, the value entered in the Frequency field determines the time between sending Query for consecutive sensors.

### Register tab

**#:** 1 (1, ..., 30)<sup>[1]</sup>

**Server:** [value] (Disabled, selection from the list of added servers)<sup>[2]</sup>

**Device:** [device address] (1, ..., 247)<sup>[3]</sup>

**Address:** [value]<sup>[4]</sup>

**Type:** **uint(16bit)** (uint (16bit), int (16bit), uint (32bit), uint (32bit) sw, int (32bit), int (32bit) sw, float (32bit), float (32bit) sw, int (64bit), double (64bit))<sup>[5]</sup>

- [1]: Ordinal number from 1 up to 30. If several sensors are connected to one sever, then Query is sending to consecutive sensors in order resulting from the ordinal number.
- [2]: Selection from the list of added servers (configuration in the *Servers* tab). It is allowed to assign the server which mode is set as *Disabled*.
- [3]: Slave device address from which the data will be read.
- [4]: Set the register's number from which data will be read. Available format: 3xxxx / 3xxxxx or 4xxxx / 4xxxxx, where: 3 – input registers, 4 – holding register and xxxx / xxxxx – four / five digit address. To speed up the communication, set consecutive register's numbers in increasing order. The value must be given in decimal system (see section [MODBUS RTU / MODBUS TCP TRANSMISSION PROTOCOL](#)).

**Notes:** It is possible to group registers, which speeds up the data transmission. If the order of addresses for consecutive registers is retained for one device and the value in the field Type<sup>[5]</sup> is chosen so that the sums of the values of the Address and Type are consecutive numbers, then one Query can obtain a value for several consecutive registers within one communication frame.

- [5]: 10 formats of readings are available in the drop-down list, where: uint – unsigned integer, int – signed integer, float – single precision floating point, double – double precision floating point, sw – swapped format (more information in section [Data types](#)). Choose a format that matches the specification of the sensor or device you are reading.

### 12.3.4 RS-485 port

Recorder RS-485 port settings must correspond to the master device settings.

**Baud Rate: 19200** (1200, 2400, 4800, 9600, 19200, 38400, 57600, 115200)<sup>[1]</sup>

**Parity: NONE** (NONE, EVEN, ODD)<sup>[2]</sup>

**ModbusRTU Address: 1** (1, 2, ..., 247)<sup>[3]</sup>

[1]: Baud Rate should be set to the highest possible value. For high distances or high interference level, data transmission speed may need to be decreased. Low transmission speed extends the reading time.

[2]: Parity control of each bite.

[3]: In RS-485 standard, up to 32 transmitters/receivers can be connected to the data transmission line. Each slave-type device must have a different address assigned.

For more information on Modbus registers addresses and data format refer to section [MODBUS RTU / MODBUS TCP TRANSMISSION PROTOCOL](#).

## 12.4 Channels settings

The channel number is selected using the drop-down list, located in the upper left corner of the screen. The description of the channel can be edited by clicking on the text in *Tag* field. Then, the screen keyboard will pop up.

For commissioning channels settings there are six settings tabs available: Inputs, General, Alarm 1, Alarm 2,  $\Sigma 1$ ,  $\Sigma 2$ .

**!** All the settings of the individual channels may be copied and pasted to another measurement channel. Detailed information is given in section [Copying channel settings](#).

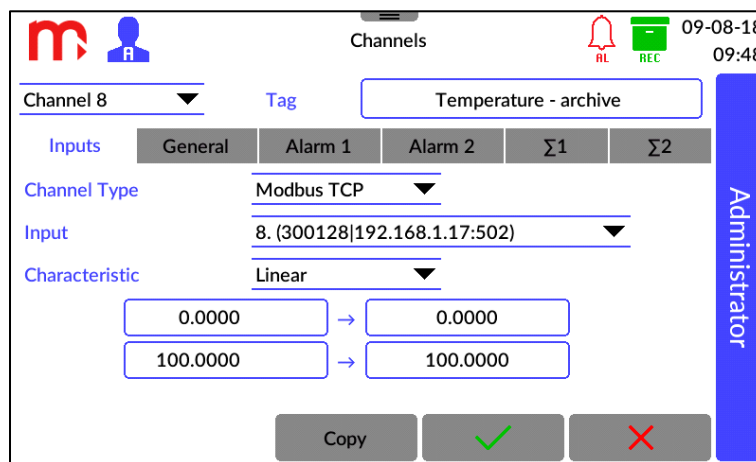

Fig. 12.4 An example view of the 'Channel' settings window.

### 12.4.1 Inputs

Depending on the channel selection, suitable settings are available:

**Channel Type: Disabled** (Disabled, Measurement, Computed, Modbus TCP, Demo(TEST))<sup>[1]</sup>

**Input: A** (A, B, M)<sup>[2]</sup>

**Input number: 1** (1, 2, 3, 4, 5, 6, CJC °C, CJC °F)<sup>[3]</sup>

**Characteristic: Linear** (Linear, depending on the module type)<sup>[4]</sup>

- [1]: The “Channel Type” possible configuration: *Disabled* – the channel is off and not displayed, *Measurement* – measured process value from input module should be assigned to the channel, *Computed* – the mathematical formula used for calculations must be entered – more details are in section [math channels](#), *Modbus TCP* – select from the drop down list the input configured in the Communication settings window ([Modbus TCP](#) tab), *Demo(TEST)* – a sin (t) function value is virtually generated, enabling e.g. the communication test without the input signals applied.
- [2]: For ‘Channel Type’ *Measurement*: a drop down list allows to select a suitable measurement module slot. After the selection, on the right side of the list, the module tag is displayed enabling its identification. For ‘Channel Type’ *Modbus TCP*: the drop-down list allows selection the appropriate sensor/device (Ethernet connection); in order to facilitate identification, the description includes: the ordinal number of the register, the device address and information about the server: IP address:Port.
- [3]: For ‘Channel Type’ *Measurement*: the drop down list allows to select an input number of the measurement card to which a selected channel is to be assigned. For the IN6TC and IN3 module, it is possible to select the CJC °C or CJC °F virtual measuring input. Temperature measurement made with using an internal sensor is assigned to the CJC inputs. The measurement can be used to compensate the cold junction temperature if the thermocouples are connected directly to the module's terminal block.
- [4]: The characteristic is typically set to "Linear". Also available are other setting options (for example [User characteristic](#)), depending on the module type. For example, for the RTD module there are characteristics of the individual sensor types available. For the CJC °C or CJC °F channel, the characteristic is typically set as 1:1. Calibration is possible by entering a User characteristic that takes into account temperature changes in individual temperature ranges or a Linear characteristic that increases or decreases the measured temperature by a fixed number of degrees. The same unit for the measured temperature and the temperature of the cold junction must be set.

**12.4.2 General**

Fig. 12.5 An example view of the 'Channel' settings window – 'General' tab.

**Unit: [None]** (text)<sup>[1]</sup>

**Time base:** - [ /s, /m, /h]<sup>[2]</sup>

**Resolution: 0** (0, 0.0, 0.00, 0.000, 0.0000)<sup>[3]</sup>

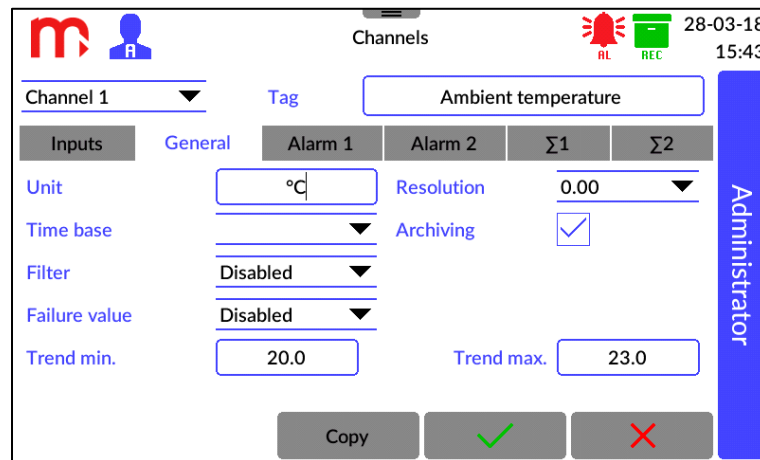
**Filter: Disabled** (Disabled, 2s, 5s, 10s, 20s, 30s, 1min, 2min, 3min, 5min)<sup>[4]</sup>

**Archiving: Disabled** (Disabled, Enabled)<sup>[5]</sup>

**Failure value: Disabled** (Disabled, Constant [value])<sup>[6]</sup>

**Trend scale:**

**Trend min.: [Value]**<sup>[7]</sup>

**Trend max.: [Value]**<sup>[7]</sup>

- [1]: The unit is provided for information purposes only. User can put in any text string which does not affect the calculated or measured results displayed by the device.
- [2]: The *Time base* is crucial only for flow measurements and totalizers calculation. In spite of *Unit* set above, it determines calculations for totalizes and flows according to /s (per second), /m (per minute) or /h (per hour) setting.
- [3]: The resolution defines the number of decimal places in the displayed result. It is unreasonable to set too high resolution for the measurement, because accuracy will not be improved (e.g. Pt100 sensor measurement set to three places after the decimal point will not provide for measurement accuracy of up to 0.001°C). However, if a filter is activated with sufficiently high time constant and if the resolution is reasonably increased, the changes can be identified more clearly.
- [4]: The filter function "smoothes out" sudden surges in the measured values or eliminates signal noise. If the filter time constant is too high, the measurement value fluctuations can be falsified by "smoothing out" the ascending and descending slopes, or by eliminating short pulses. The filter time constant should be customized to the maximum speed of changes in the measured process.
- [5]: It enables on/off the archiving of the results to a file in internal archive memory.
- [6]: The failure value is the constant value which is displayed instead of the measurement result if the input signal fails or calculation result is out of range.
- [7]: This option enables set the span of the scale displayed on the trend graph in the single result window.

### 12.4.3 Alarm

**Mode: Disabled** (Disabled, Low, High)<sup>[1]</sup>

**Type: Alarm** (Control, Alarm)<sup>[2]</sup>

**Level: [None]** (text)<sup>[3]</sup>

**Hysteresis: [None]** (text)<sup>[4]</sup>

**Colour: Disabled** (Disabled, Green, Yellow, Red)<sup>[5]</sup>

**Output: --** (--, A, B, M)<sup>[6]</sup>

**Change the frequency of archiving: Disabled** (Disabled, Enabled)<sup>[7]</sup>

**Log event: Disabled** (Disabled, Enabled)<sup>[8]</sup>

**E-mail Notification: Disabled** (Disabled, Enabled)<sup>[9]</sup>

- [1]: The threshold can be set to *High* (active above a specific level) or *Low* (active below a specific level) operation mode.
- [2]: Setting of the *Type: Alarm* (or so called latched mode) allows to indicate the alarm notification with confirmation procedure. *Type: Control* (or so called non-latched mode) allows to indicate the threshold status or use relays outputs to set a simple on/off control (e.g. heating or cooling).
- [3]: The alarm threshold level value is entered in the measured value units assigned.
- [4]: The hysteresis value is the difference between the threshold value exceedance and return to normal. The threshold hysteresis value is entered in units of the measured value assigned to a specific measurement channel. For example, for a threshold set to *High*, 48 °C threshold level and 0.5 °C hysteresis means that the threshold will be exceeded above 48 °C, and will return to normal below 47.5 °C (48-0.5). For a threshold set to *Low*, -15 °C threshold level and 0.2 °C hysteresis means the threshold will be exceeded below -15 °C, and will return to normal above -14.8 °C (-(-15-0.2)).
- [5]: Each alarm/control threshold can have a colour assigned. If the threshold is exceeded, the measurement result is displayed in a different colour: *Green*, *Yellow* or *Red* (assigned to this alarm).
- [6]: The drop down list enables selecting a suitable module and output to which the used output relay is connected. After the selection, below the list, the module tag is displayed enabling its identification.
- [7]: The recording of measurement results can be controlled by alarm/control thresholds. Two different recording speeds can be set. The exceeded threshold can switch from MAIN ARCHIVE interval I to MAIN ARCHIVE interval II – more information about archive interval in section [Archive settings](#).
- [8]: Enabling the option switches on the archiving of the thresholds exceeded to the event file.
- [9]: Enabling the option activates the function of informing about exceeding the alarm / control threshold and returning to the normal value by means of e-mails ([E-mail settings](#)). An e-mail about returning to the normal value will be sent automatically for the *control* alarm type, for the *alarm* type after the confirmation the alarm.

### 12.4.4 Totalizers

**Mode: Disabled** (Disabled, Unresettable, Resettable, Daily, Weekly, Monthly)<sup>[1]</sup>



**Unit: [None]** (text)<sup>[2]</sup>

**Multiplier: 1** (0.001, 1, 1000)<sup>[3]</sup>

**Resolution: 0** (0, 0.0, 0.00, 0.000, 0.0000)<sup>[4]</sup>

**Archiving: Disabled** (Disabled, Enabled)<sup>[5]</sup>

**E-mail Notification: Disabled** (Disabled, Enabled)<sup>[6]</sup>

- [1]: Each totaliser may be set in one of the six options: *Disabled* – values are not counted, *Unresettable* – user cannot zero the totaliser, *Resettable* – user can zero the totaliser at any moment, *Daily* – the totaliser is erased every 24 hours, *Weekly* - the totaliser is erased after the elapse of a week, *Monthly* - the totaliser is erased after the elapse of a month.
- [2]: The unit is provided for reference purposes only. User can enter any unit which does not affect the results displayed by the device.
- [3]: The multiplier allows multiplication of the measurement results by one of the three values selected from the list. For example, if a flow meter is connected to the device measuring the flow in m<sup>3</sup>/s and the user wants the result to be displayed in dm<sup>3</sup>/s, the multiplier should be set to 1000. In a reverse situation, when the measurement would be made in dm<sup>3</sup>/s and the user would like the values counted by the totaliser to be displayed in m<sup>3</sup>/s, the value of the multiplier should be set to 0.001.
- CAUTION!** It has to be remembered that the multiplier value does not determine the displayed unit and vice versa.
- [4]: The number of decimal places displayed. It has no effect on the calculation accuracy and can be changed any time without affecting the totalizer status.
- [5]: Enables on/off the totalizer archiving. Selecting the check-box is equivalent to switching on the archiving.
- [6]: Enables adding the totalizer value to an e-mail sent in the form of a cyclic report ([E-mail](#) settings).





**For some modules, the view of individual tabs may be slightly different from those described above.**

## 12.5 Screen settings

'Screens' setting window enables setting display parameters in *Results Tables* window and in *Trends* window. Switching between settings windows is possible by using tabs.

Switching between individual setting of result tables/trends is possible by using drop down list, located in the upper left corner of the screen. It is possible to define six tables and six trends. Each table/trend may have individual tag. Changing tag of table/trend is possible after pressing the current one in the *Tag* field.

In the case when for a specific trend/table the displayed value is not set, this trend/table will not be displayed in the *Results Tables* window and in the *Trends* window.

Confirm  and cancel  buttons are common for both sub-windows, clicking on these buttons results in toggles to the Main Menu.



### 12.5.1 Results Tables

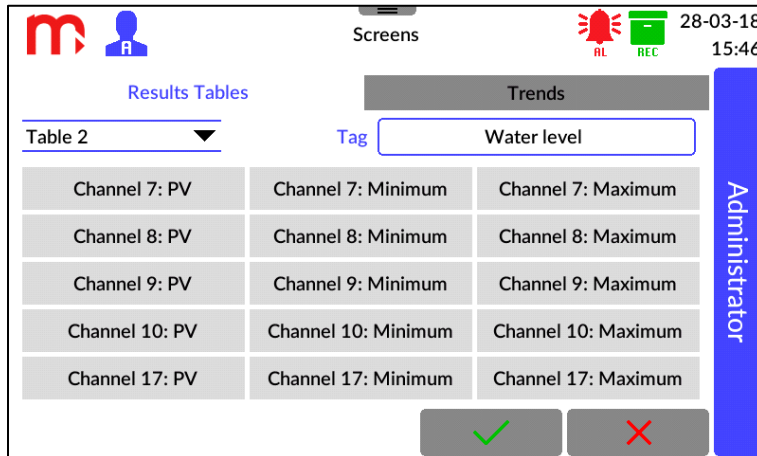

Fig. 12.6 An example view of the 'Screen' setting window (edition of the Result Tables window).

In the upper part of the window there is a drop-down list, from which can be selected the table, which will be modified. On the right side of the list, there is a field where for each item can be given any name, however not exceeding 20 characters.

Below, there is the outline of the table. Unprogrammed cells are marked with an inscription - **Disabled**. Changing the displayed values is possible after pressing the appropriate table cell. Click on the cell you want to programme and then select a suitable measurement channel from the drop-down list (Channel 1-30). It will display another list enabling selection of the displayed value. User has five options to choose from: **PV** - Process value, **Maximum** - Maximum value, **Minimum** - Minimum value,  $\Sigma 1$  - Totaliser 1,  $\Sigma 2$  - Totaliser 2.

### 12.5.2 Trends

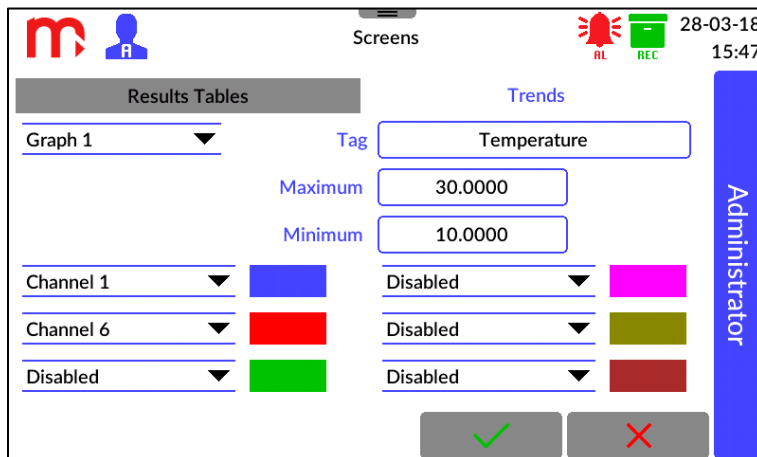

Fig. 12.7 An example view of the 'Screens' settings window (edition of the Trends window).

In the upper part of the window, there is a drop down list from which user can select one of the six available graph for programming. There is a field on the right side of the list where for each item can be given any name, however not exceeding 20 characters.

For each from six graph, it is possible to programme 6 trend lines. Each of them has a different colour assigned. To programme the lines, from the drop-down lists, situated next to the individual colour fields, select a suitable measurement channel. Additionally, it is possible to define the graph scale as a maximum and minimum value.

## 12.6 Archive settings

The window is divided into two parts, the upper part enables commission the archive parameters, using the drop-down lists.

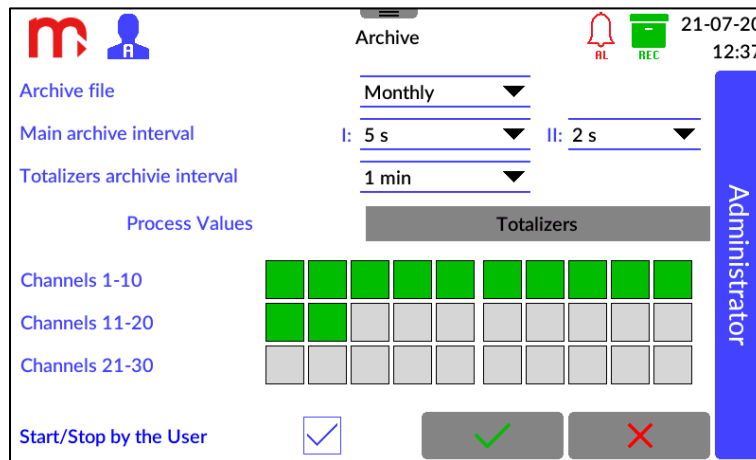

Fig. 12.8 An example view of the 'Archive' settings window.

**Archive file:** Daily (Daily, Weekly, Monthly)<sup>[1]</sup>

**Main archive interval**

**I: 2s** (2s, 5s, 10s, 15s, 30s, 1min, 5min, 10min, 15min, 30min, 1h, 2h, 4h, 12h, 24h)<sup>[2]</sup>

**II: 2s** (2s, 5s, 10s, 15s, 30s, 1min, 5min, 10min, 15min, 30min, 1h, 2h, 4h, 12h, 24h)<sup>[3]</sup>

**Totalizers archive interval: 1min** (1min, 5min, 10min, 15min, 30min, 1h, 2h, 4h, 12h, 24h)<sup>[4]</sup>

- [1]: The archiving files are created in the daily, weekly and monthly system.
- [2]: The basic MAIN ARCHIVE time interval (I). Recording interval should correspond to the measurement process. If the recording interval is too short, the large data volumes will make it difficult to analyse the results. If the recording interval is too long, rapid changes in the measured values cannot be identified.
- [3]: The second MAIN ARCHIVE time interval (II) is used when the recording is controlled by exceeded alarm/control thresholds (see section [Alarm](#)).
- [4]: The time interval with which the totalizers data are saved in the archive.

Below, **Process Values** and **Totalizers** are displayed, switching between windows is possible by using tabs.

### Process Values tab

The window displays the current status of the process values recording. Gray rectangle means that the value is not archived, green means archiving.

### Totalizers tab



The window displays the current status of the totalizers recording. Each rectangle divided into two parts, represents both, Totaliser 1 and Totaliser 2, for every channel. Gray color means not archived, green means archived.

In the Archive window, only the information about the archive status is displayed. Turning archiving on and off for each channel is possible in the Channels settings window (more information in section [Channels](#)). In the window Administrator may deprive the User of the ability to control the archive operation (Start/Stop by the User).

## 13 ARCHIVE

### 13.1 Start, resume and stop archiving

The Archive window is displayed after pressing the  button on the menu bar. Using the function buttons, it is possible to start, resume or stop the archiving process.

In the left bottom corner of the screen, there is a button which may start the archiving process  or stop it .

To create a new archive, in first step stop the archiving process and then press the button . After creating a new archive file, it is necessary to start the archivization (press **START** button).



**Turning off the power supply may cause the loss of a few last records (approx. 1 minute).**

### 13.2 Archive settings

The archive settings are available after clicking the  button on the menu bar, and then the archive icon (detail in section [Archive settings](#)).

### 13.3 Archive files types

There are three archive file types:

- Data archive (file name organization: **YYADXX.csv**)
- Totalizer archive (file name organization: **YYATXX.csv**)
- Event archive (file name organization: **YYAEXX.csv**)

XX - successive archive file number, starts from 01 and ends at 99. If this number is exceeded, the numbering is resumed from 01.

YY - device ID; it is consistent with the user settings, in case of change the ID, a new file will be created.

Each archive is recorded in the \*.csv format (standard spreadsheet text format).

### 13.4 Way of creating an archive file

The archive file with a new archive number is created in the following cases:

- creating a new file by the user,
- cyclically (daily, weekly, monthly), according to the set parameter,
- changing parameters, necessitating the creation of a new file.

A new archive file is created in case of the absence of an archive file.

### 13.5 Time interval of archiving data

Process Values records are saved every 2 s, 5 s, 10 s, 15 s, 30 s, 1 min, 5 min, 10 min, 15 min, 30 min, 1 h, 2 h, 4 h, 12 h or 24 h, according to the settings. (More information in section [Archive setting](#)).

Totalizers records are saved every 1 min, 5 min, 10 min, 15 min, 30 min, 1 h, 2 h, 4 h, 12 h, 24 h, according to the settings. (More information in section [Archive setting](#)).

Record in event archive is added when the event occurs (e.g. power on/off, alarm exceeded, device parameters changed, user login).

### 13.6 Archive files organization

Each archive file contains a header, with the following information:

**DEVICE MODEL, FW VERSION, SERIAL NUMBER, ID, NUMBER OF ROW, ARCHIVE TYPE, CRC1**

- DEVICE MODEL** – device model, for DL2 it is DL2
- FW VERSION** – the firmware version in which the archive was created, updating the FW will always result in the creation of a new archive
- SERIAL NUMBER** – serial number of the device
- ID** – device ID
- NUMBER OF ROW** – information about the number of rows in the header
- ARCHIVE TYPE** – archive type: DATA (process value archive), EVENT (event archive), TOT (totalizer archive)
- CRC1** – CRC control

The process values archive and totalizers archive also has an additional archive header, which contains information about set parameters (selected channels, description, unit, etc.).

#### 13.6.1 Data archive

Organization of additional header in the data archive file:

**CHANNEL, DESCRIPTION, UNIT, INPUT TYPE, INPUT NO**

- CHANNEL** – the channel number
- DESCRIPTION** – channel description, depending on the settings in the device
- UNIT** – unit assigned to the channel
- INPUT TYPE** – the type of measurement input assigned to the channel: ME (measured), CO (computed), RE (Modbus TCP), DE (Demo(TEST)), -- (disabled).
- INPUT NO** – for *Measurement* channel type: number of the assigned measurement input: XY (X - module number, Y number of input on the module); for *Modbus TCP* channel type: number of registers (1 .. 30); for *Computed*, *Demo(TEST)* and *Disabled* channel type: --

Organization of records in the data archive file:

**DATE, TIME, DST, CH 1, CH 2, ... , CH 30, CRC**

- DATE** – date of the record in YY-MM-DD format
- TIME** – time of the record in HH:MM:SS format
- DST** – information about summer (1) or winter (0) time enabled
- CH X** – value (X – channel number from 1 to 30)
- CRC2** – CRC control

### 13.6.2 Totalizer archive

Organization of additional header in the totalizers archive file:

**CHANNEL, DESCRIPTION, TOTALIZER 1 TYPE, TOTALIZER 1 UNIT, TOTALIZER 2 TYPE, TOTALIZER 2 UNIT**

**CHANNEL** – the channel number  
**DESCRIPTION** – channel description, depending on the settings in the device  
**TOTALIZER 1 TYPE/**  
**TOTALIZER 2 TYPE** – totalizer operation mode: ‘ ‘ – disabled; ‘1’ – unresettable; ‘2’ – resettable; ‘3’ – daily; ‘4’ – weekly; ‘5’ – monthly  
**TOTALIZER 1 UNIT/ TOTALIZER 2 UNIT** – unit assigned to the totalizer

Organization of records in the totalizers archive file:

**DATE, TIME, DST, CH1:T1, CH1:T2, CH2:T1, ... , CH30:T2, CRC2**

**DATE** – date of the record in YY-MM-DD format  
**TIME** – time of the record in HH:MM:SS format  
**DST** – information about summer (1) or winter (0) time enabled  
**CHXX:TY** – value of totalizer (XX – channel number from 1 to 30; Y – totalizer number: 1 or 2)  
**CRC2** – CRC control

### 13.6.3 Event archive

Organization of records in the events archive file:

**DATE, TIME, DST, EVENT CODE, CRC2**

**DATE** – date of the record in YY-MM-DD format  
**TIME** – time of the record in HH:MM:SS format  
**DST** – information about summer (1) or winter (0) time enabled  
**EVENT CODE** – event code (more information below)  
**CRC2** – CRC control

The event archive records the following events:

<b>SYS:STOP</b>	Power supply switched off
<b>SYS:START</b>	Power supply switched on
<b>ARCH:NEW</b>	Created a new archive file
<b>ARCH:STOP</b>	Stopped archivization
<b>ARCH:START</b>	Started archivization
<b>SYS:NEW SETTINGS</b>	New settings saved
<b>SYS:TIME CHANGED</b>	Changed time
<b>SYS:DATE CHANGED</b>	Changed date
<b>SYS:CHx: AUX VALUES RESET</b>	Reset auxiliary values for "x" channel (min, max, totalizers)



---

<b>SYS: ALL CHANNELS: AUX VALUES RESET</b>	Reset auxiliary values on all channels (min, max, totalizers)
<b>AL:ACK</b>	Acknowledged alarms
<b>AL:CHx ALy ON</b>	Activated the "y" alarm on the "x" channel
<b>AL:CHx ALy OFF</b>	Deactivated the "y" alarm on the "x" channel
<b>EMAIL:OK</b>	Sending an e-mail
<b>EMAIL:ERROR</b>	Attempt to send e-mail messages failed
<b>SYS:BOARD x RESET</b>	Restarted the "x" board due to a communication error
<b>SYS:WATCHDOG RESET</b>	Restarted device due to Watchdog timeout
<b>SYS:LOGIN: xxxxx</b>	Login user xxxxx
<b>SYS:LOGOUT</b>	Logout the user

### 13.7 Copying archive files from the device

Copying archive files from the device is possible in two ways: using a USB flash memory (a USB stick) or using an Ethernet connection and the device web server.

#### 13.7.1 Copying archive files to USB flash memory

Connect the USB flash memory to the USB port in the front panel of the device. Click the  button from the menu bar, then click the  icon.

Process of deleting and copying files to USB is described in the [USB](#) section.

#### 13.7.2 Copying archive files using device web server

Archive files can be copied using the device web server. Connect the device using the Ethernet connection and follow the instruction from section [Web server](#).

### 13.8 Automatic disk cleaning system

The device has an automatic disk cleaning system.

Disk cleanup starts when you exceed 95% capacity. Cleaning occurs until 90% of the disk capacity is reached. If the disk cannot be cleaned to 90%, it will end sooner.

If the disk is between 91% and 94% full after the cleanup, the cleanup will complete correctly and the backup will continue.

If the disk is still full above 95% after cleaning, an error will be triggered and archiving will stop.

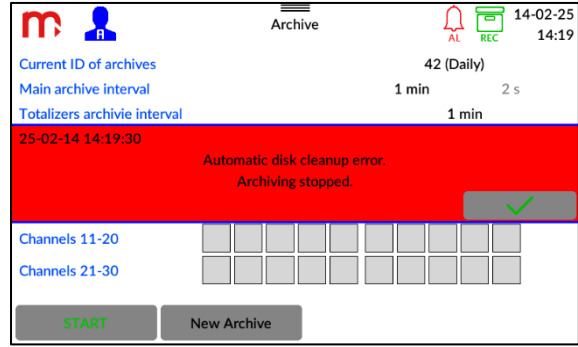
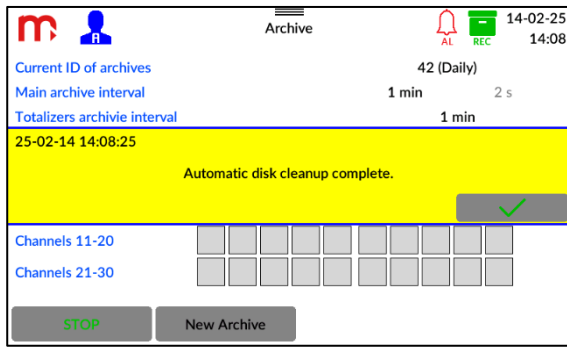



Fig. 12.9 Automatic disk cleanup messages.

## 14 ADDITIONAL FUNCTIONS

### 14.1 Additional channel functions

#### 14.1.1 Math channels

In order to set the calculation channel, choose from the menu bar the  button and then the channels icon . In the input tab, set the channel type: *Computed* and enter the formula which the value will be calculated.

The device allows to perform selected mathematical operations: addition, subtraction, division, multiplication, raising to the 2, 3 or any power and the square root. The entered formula can contain up to 200 characters.

**! The device performs calculations according to the order of operations (operations in brackets, exponentiation / extraction of a root, division / multiplication, addition / subtraction).**

The value of another channel may be used in the calculations. In this case, the channel number should be preceded by prefix '#’.

In the formula may be used:

- channel value (**#x**, where x – channel number)
- totalizer value (**Σy#x**, where y – totalizer number, x- channel number)
- channel alarm status (**@y#x** , y - the alarm number, x – channel number)

Example:

- formula **#1 + #2** sums up the values of channel 1 and channel 2
- formula **Σ1#1 + Σ1#2** sums up the value of totalizers Σ1 of channel 1 and totalizer Σ1 of channel 2
- formula **@1#1 x #2** multiplies the alarm status (0 or 1) of channel 1 by value of channel 2

In calculation of square root, the value is calculated of only first character after the  $\sqrt{\quad}$  mark. If the square root has to be calculated from the value of several channels, calculated value should be placed in brackets.

For example:

- formula  $\sqrt{123}$  calculates the square root of 123
- formula  $\sqrt{\#1}$  calculates the square root of the value of channel 1
- formula  $\sqrt{\#1+\#2}$  calculates the square root of channel 1 and to the result adds the value of channel 2
- formula  $\sqrt{(\#1+\#2)}$  calculates the square root of the sum of values channels 1 and 2.

Similarly, in the case of exponentiation (the possibility of choosing the second and the third power), the value is calculated of only the first character entered before the <sup>2</sup> or <sup>3</sup> mark. If the value from several channels is raised to power 2 or 3, the calculated value should be put in brackets.

For example:

- formula **123<sup>2</sup>** raises the value of 123 to power 2



- formula  $\#1^2$  raises the value of channel 1 to the power of 2
- formula  $\#1+\#2^2$  raises the value of channel 2 to the power of 2 and adds the value of channel 1
- formula  $(\#1+\#2)^2$  raises to the power of 2 the value from the sum of values of channels 1 and 2

The device can raise the value to any power (the ^ mark). For an exponent that is not an integer, the base must be positive. If the value from several channels has to be raised to selected power, the value should be put in brackets. If the exponent contains more than one sign, place it in brackets.

For example:

- formula  $123^4$  raises 123 to the power of 4
- formula  $123^{(-4)}$  raises 123 to the power of -4
- formula  $123^4^3$  means  $123^{4 \cdot 3}$
- formula  $123^{(4^3)}$  means  $123^{4^3} = 123^{64}$
- formula  $\#1^{(1 \div 3)}$  raises to the power of  $\frac{1}{3}$  the value of channel 1
- formula  $\#1^{(\#2)}$  raises the value of channel 1 to the power equal to the value of channel 2
- formula  $\#1+\#2^{(1 \div 3)}$  raises to the power of  $\frac{1}{3}$  the value of channel 2 and adds to the value of channel 1
- formula  $(\#1+\#2)^{(1 \div 3)}$  raises to the power of  $\frac{1}{3}$  the the sum of values of channel 1 and channel 2
- formula  $(\#1)^{(\#2+\#3)}$  raises the value of channel 1 to the power of the sum of the values of channels 2 and 3

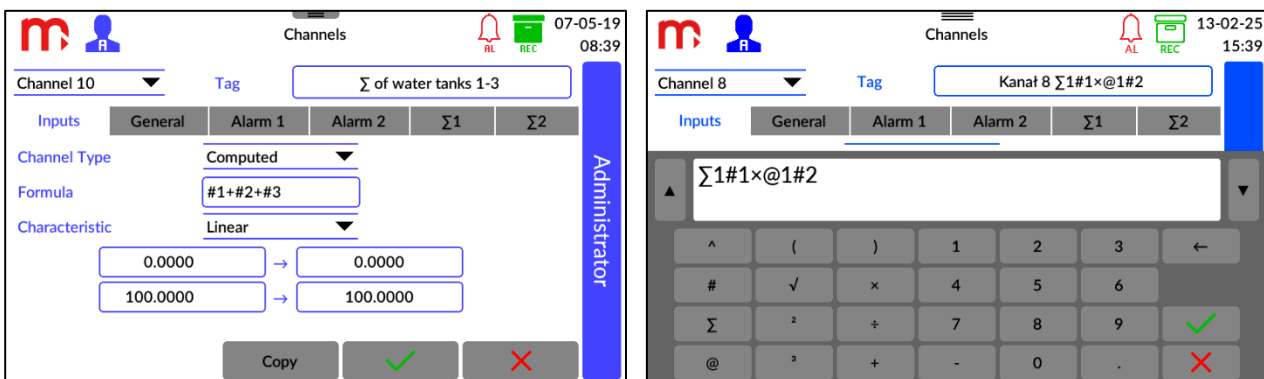

Fig. 14.1 Settings of math channels - entering the formula of the math channel.

Math channels have the same functions that allow analysis as measurement channels: they can be displayed in the [Result Tables](#) window, in the [Trends](#) window and in a [single result window](#). It is possible to set alarms ([Alarms](#)) and archive their values ([Archive](#)).

### 14.1.2 User characteristics

User characteristics are given in the form of a pair of points: the value of the measured resistance, current, voltage, etc. (x value) and the value displayed in the corresponding units (y value). The user has the ability to add (**Add point**), delete (**Delete point**), and edit (**Edit value**) points of the characteristic, with a minimum of 2 points and a maximum of 100. User has the ability to add up to 10 characteristics.

To add a new characteristic, in the **Channel** settings window, select from the drop-down list in field Characteristics: *User*, then select one of the ten available positions and select **View** button. Changing the characteristic tag after clicking on the current one in the *Tag* field.

New points can be added in any order (**Add point**), because they are automatically recognized and sorted relative to the measured value x. To delete a point, select it by clicking and then select **Delete point** button. To edit a point, select it by clicking and then select **Edit Point** button.

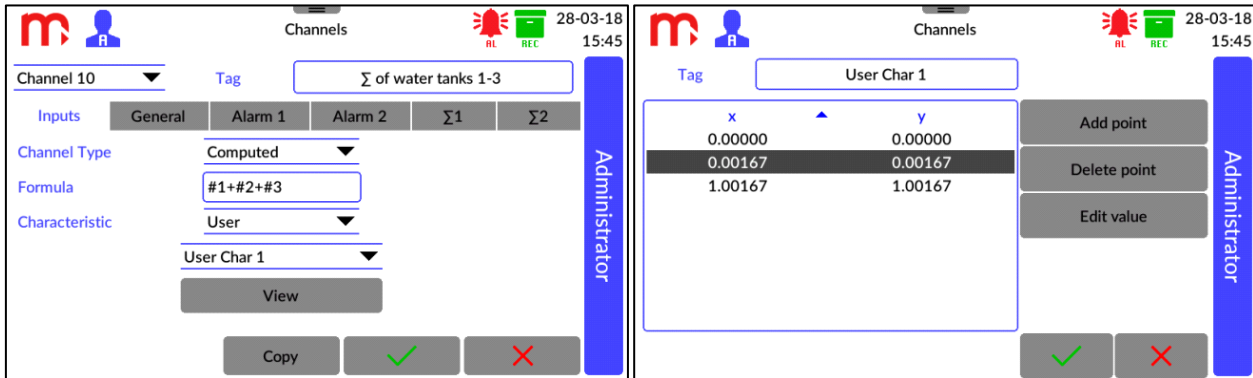

Fig. 14.2 An example view of the 'Channel' settings window (edition of user characteristics).

Two identical measurement values x cannot be entered for the same characteristic. The entered data will be treated as erroneous and will be highlighted in red.

After entering the points for the characteristic, confirm the willingness to make changes by pressing the button . To cancel implemented changes, press the button .

In the *DL2 Config* program it is possible to add a characteristic from the computer level. The file with characteristics points must be in \*.csv format. The columns in the file must be signed as 'x' (previous column) and 'y' (next column). Use a decimal point.

### 14.1.3 Copying channel settings

The device enables copying the settings assigned to a particular measurement channel and pasting them into another channel. It allows to speed up the programming when there are channels to be programmed with using the same settings. After pasting, change the address of the measurement input and the name of the channel.



To copy the settings, from the list in the top part of the **Channels** setting window select the channel which is to be copied and then select the button. Then, choose the channel to which the settings are to be copied and click the button.

Both function buttons are located in the bottom of the screen.

### 14.2 Print screen

To use the print screen option click on the manufacturer's logo . During this operation, the screen will be inactive for a few seconds and the process will be signalled by a blue diode situated on the front panel of the device. When the process is completed, an information will be displayed on the screen. Confirm the information.

Internal memory in the device may store up to 10 print screen numbered from 0 to 9. If this number is exceeded, the numbering is resumed from 0, and the images are overwritten. All files are saved in the \*.bmp format.

To copy the image from the device to a USB flash memory, use the  button from the menu bar and then click on the  icon.

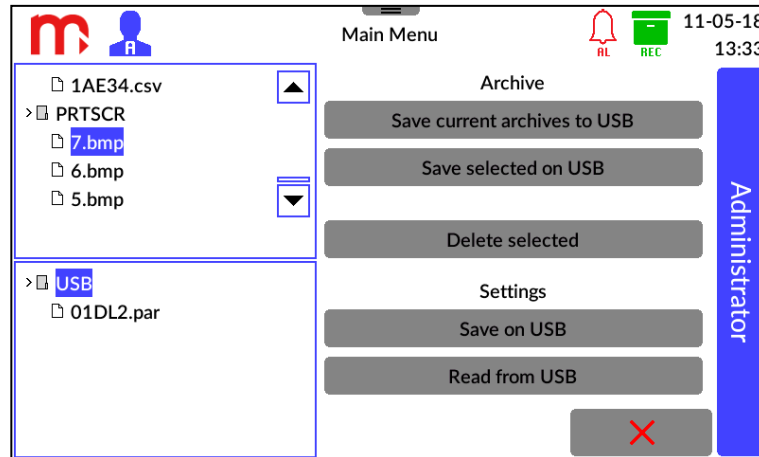



Fig. 14.3 Saving the print screen file.

Among the files situated in the window on the left side of the screen, from the **PRTSCR** folder select the file to be copied (folder is at the bottom of the list). The selection will be confirmed by marking the name in blue. Then, from the menu on the right side click on the **Save selected on USB** button.

### 14.3 Web server

Web server enables viewing the Result Tables and download archive files using a web browser.

In order to start the web server, the IP address of the device (information available in the [Information about the device](#) window) should be placed in the browser's address bar.

The IP address should be configured in the menu of the device, in Communication setting window ( →  → **Ethernet** tab).

Choose language by clicking on the appropriate flag icon. Then, log in with the **User's** password. In case that this password is disabled, the page will automatically load the list of archives.



Fig. 14.4 Login to the web server.

DL2			
Tabela 1	Tabela 2	Σ1: Gas mass flow	Σ2: Gas mass flow
Gas mass flow	-10.000 kg/m³	295083 kg	295083 kg
Air volumetric flow	5.00 m³/h	802437 m³	802437 m³
Kanal 8 Σ1#1*~@1#2	0		
Kanal 9 Σ1#1+Σ2#1	590167		

Fig. 14.5 Web server view - Result Tables.

Tables with the current values are in *Result Tables* tab. It should be taken into account that the page does not refresh automatically. To refresh data, press the **Refresh** button under the table.

Results Tables	Name	Size
2AD30.csv	2025-02-06 09:49	0.26 kB
2AE30.csv	2025-02-06 13:24	0.58 kB
2AD31.csv	2025-02-06 13:24	0.26 kB
2AE31.csv	2025-02-06 13:29	0.39 kB
2AD32.csv	2025-02-06 13:29	0.27 kB
2AE32.csv	2025-02-06 13:32	0.27 kB
2AD33.csv	2025-02-06 13:32	0.27 kB
2AE33.csv	2025-02-07 11:39	0.25 kB
2AD34.csv	2025-02-07 11:39	0.27 kB
2AE34.csv	2025-02-11 10:59	4.66 kB
2AD35.csv	2025-02-11 10:59	0.27 kB
2AE35.csv	2025-02-11 11:06	0.36 kB
2AD36.csv	2025-02-11 11:07	0.28 kB
2AE36.csv	2025-02-11 11:08	0.22 kB
2AD37.csv	2025-02-11 11:08	0.28 kB

Fig. 14.6 Web server view - List of archive files.

List of the archive files is in *Archive* tab. The files are downloaded to the computer by clicking on the assigned archive name in the list of archive files. It is possible to sort archive files by pressing on the name of the column header in the table.

## 14.4 Software for PC

### 14.4.1 DL-Config

The program is used to commission the device parameters. The parameters between the device and the program are transferred with using \*.par files. Number of possible cards to be installed is 2, the program adds the main card in the slot M by default.

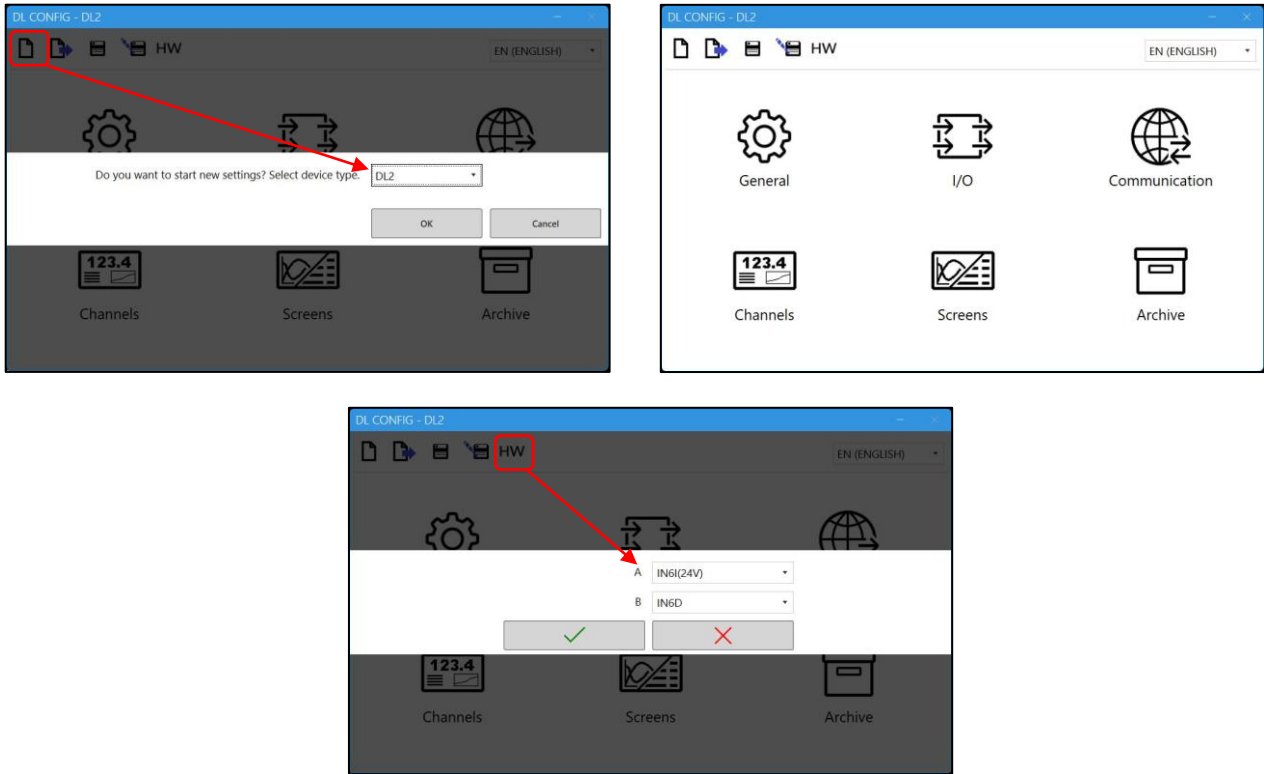

Fig. 14.7 An example view of the DL-Config program.

### 14.4.2 M-Report

The program is used for analysis and visualization of measurement results. Depending of the archive type, measurement results may be presented in a graph or in the table. In extended version *M-Report.exe* there is possibility to download archive files from the device via Ethernet connection.

More information in instruction manual for the M-Report program.

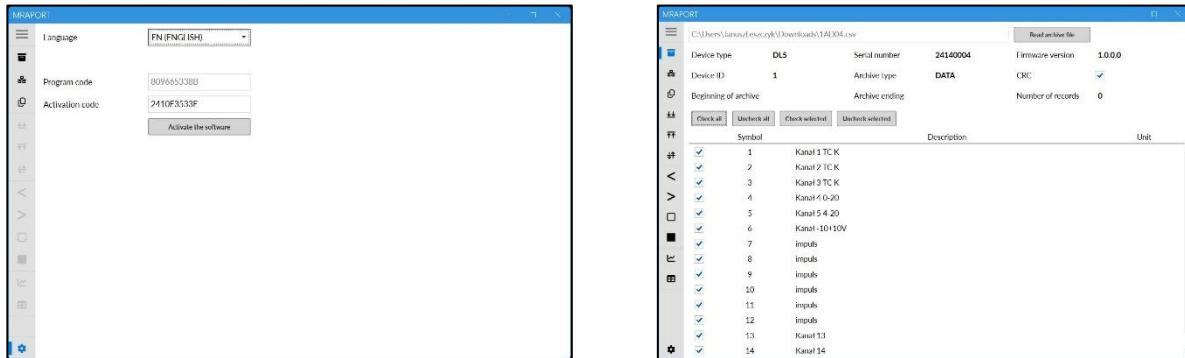

Fig. 14.8 An example window view in the M-Report program.

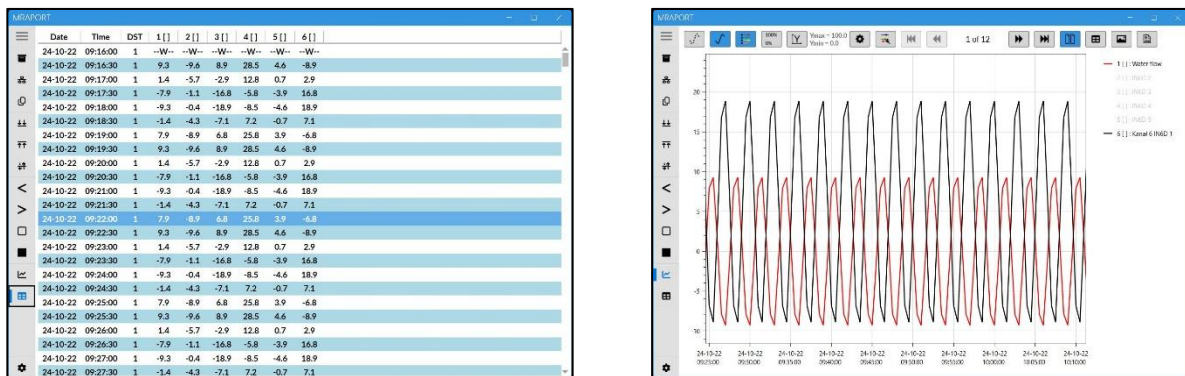

Fig. 14.9 An example window view in the M-Report program, data in a table and a graph.

## 15 FAILURE SYMBOLS

Fault situation related to a particular channel are marked with a relevant symbol on the display:

- Channel switched off, the symbol is displayed in the trend and collective tables window, for the switched off channels the single result window is not displayed. The symbol is displayed for the disabled input, empty slot (without a connected module) or for the connected PSBATT module in version 1.0 or in version 1.1.
- Exceeding the measuring range, a value is less or equal to -999999999999999 or a value is greater than or equal to 999999999999999. The symbol is saved in the archive and sent in an e-mail.
- Symbol of disabled channel saved in the archive.
- W--- Wait, value not available - it is displayed when the channel is connected to the input which has not been yet configured. It is usually displayed in the beginning of the device operation.
- ||--- Circuit break, concerns only the current modules set to 4-20mA mode.
- E--- Value out of the range (exceeded) for the input card.
- R--- Value out of the range for the sensor.
- ERR-- Measurement error due to reason other than those referred to above.

### 15.1 Failure symbols for 1HRT module

- W--- Wait, value not available - it is displayed during starting the module and during establishing a connection with the sensor.
- ||--- No sensor connected (circuit break).
- E--- Incorrect HART frame (incorrect CRC, incorrect preamble length).
- ERR-- HART status is 'incorrect' (it is displayed if Status is enabled in the I/O Settings window for the selected variable).

## 16 MODBUS RTU / MODBUS TCP TRANSMISSION PROTOCOL

### 16.1 General information

Process values and totalizers are available as *holding registers* and *input registers*. It is only possible to read the data.

#### 16.1.1 Data types

uint/int 16bit	<i>Reg (Bit 15...0)</i>	
	HByte	LByte
	2.	1.

uint/int/float 32bit	<i>Reg_L (Bit 15...0)</i>		<i>Reg_H (Bit 31...16)</i>	
	HByte	LByte	HByte	LByte
	2.	1.	4.	3.

uint/int/float 32bit sw	<i>Reg_H (Bit 31...16)</i>		<i>Reg_L (Bit 15...0)</i>	
	HByte	LByte	HByte	LByte
	4.	3.	2.	1.

int/double 64bit	<i>Reg_L (Bit 15...0)</i>		<i>Reg_H (Bit 31...16)</i>		<i>Reg_L (Bit 47...32)</i>		<i>Reg_H (Bit 63...48)</i>	
	HByte	LByte	HByte	LByte	HByte	LByte	HByte	LByte
	2.	1.	4.	3.	6.	5.	8.	7.

### 16.2 Registers addresses

Process values are available in the floating-point format as per IEEE-754 for the 32-bit digit type with the floating point and single precision (32-bit floating point single).

The totalizers are available in the floating-point format as per IEEE-754 for the 64-bit digit type with the floating point and double precision (64-bit floating point double).

#### 16.2.1 Addresses table of Process values

No. measuring channel	Register number	Modbus address	Size (in registers)
1	300000 / 400000	00	2 (32bit float)
2	300002 / 400002	02	2 (32bit float)
...	...	...	...
...	...	...	...
29	300056 / 400056	56	2 (32bit float)
30	300058 / 400058	58	2 (32bit float)



**16.2.2 Addresses table of Totalizer 1**

No. measuring channel	Register number	Modbus address	Size (in registers)
1	300060 / 400060	60	4 (64bit double)
2	300064 / 400064	64	4 (64bit double)
...	...	...	...
...	...	...	...
29	300172 / 400172	172	4 (64bit double)
30	300176 / 400176	176	4 (64bit double)

**16.2.3 Addresses table of Totalizer 2**

No. measuring channel	Register number	Modbus address	Size (in registers)
1	300180 / 400180	180	4 (64bit double)
2	300184 / 400184	184	4 (64bit double)
...	...	...	...
...	...	...	...
29	300292 / 400292	292	4 (64bit double)
30	300296 / 400296	296	4 (64bit double)

**16.2.4 Alarm status addresses and alarm acknowledgements**

Alarm states and alarm acknowledgement are available as Discrete Inputs, Discrete Coils

Value [ 0, 1 ]

Alarm status and alarm acknowledgement are available as a boolean sum

Holding Registers, Input Registers. Variable Integer 16 bit.

Value (logical sum of alarm status and acknowledgement status)

0 – No alarm, no acknowledgement

1 – Alarm active, no acknowledgement

2 – No alarm, alarm confirmed

3 – Alarm active, Alarm acknowledged

Channel No.	AL1	AL2	Pot. AL1	Pot. AL2	AL1+Pot.	AL2+Pot.
	<i>Digital Input</i>	<i>Digital Input</i>	<i>Digital Input</i>	<i>Digital Input</i>	<i>Integer 16bit</i>	<i>Integer 16bit</i>
<b>1</b>	0	30	60	90	300	330
<b>2</b>	1	31	61	91	301	331
...	...	...	...	...	...	...
...	...	...	...	...	...	...
<b>29</b>	28	58	88	118	328	358
<b>30</b>	29	59	89	119	329	359

